



Horizontal Stacker

Copyright © 2019, 2024 MiTek®. All rights reserved.

001011MANUAL REV. E

Patented. See Legal Notice for list of patents.

Manual applies to United States equipment.



CAUTION: MiTek recommends printing this manual in high resolution using color ink. Many of the graphics may be unclear and may create an unsafe condition if this recommendation is not followed.



Horizontal Stacker

MiTek Machinery Division
301 Fountain Lakes Industrial Drive
St. Charles, MO 63301
Phone: 800-523-3380
Fax: 636-328-9218
www.mitek-us.com

Part # and Rev.	001011MANUAL REV. E
Date Printed	14 June 2024
Date Created	22 September 2017
Created By	G. Gaia
Approved By	M. Kanjee
Date Revised	24 May 2024
Revised By	R. Tucker

Legal Notice

Patents

Made and sold under one or more of the following patents:

U.S. 4,986,052	U.S. 5,837,014	U.S. 6,219,975
U.S. 5,385,339	U.S. 5,854,747	U.S. 6,260,263
U.S. 5,493,834	U.S. 5,873,567	U.S. 6,317,980
U.S. 5,568,862	U.S. 5,884,448	U.S. 6,389,762
U.S. 5,630,697	U.S. 5,885,731	U.S. 6,401,422
U.S. 5,636,494	U.S. 5,906,264	U.S. 6,412,246
U.S. 5,638,658	U.S. 5,934,866	U.S. 6,418,601
U.S. 5,640,832	U.S. 5,947,460	U.S. 6,539,615
U.S. 5,655,399	U.S. 5,987,828	U.S. 6,666,367
U.S. 5,678,395	U.S. 5,996,303	U.S. 6,702,269
U.S. 5,702,095	U.S. 6,048,165	U.S. 6,758,022
U.S. 5,707,204	U.S. 6,112,968	U.S. 6,817,392
U.S. 5,735,087	U.S. 6,134,775	U.S. 6,834,470
U.S. 5,810,341	U.S. 6,170,688	U.S. 6,907,820
U.S. 5,819,412	U.S. 6,205,637	
U.S. 5,833,222	U.S. 6,212,849	Other patents may apply

Return Goods Policy

Return goods cannot be accepted without prior authorization and are subject to a restocking charge. The Seller certifies the articles specified herein were produced in compliance with all provisions of the Fair Labor Standards Act of 1938, as amended, including Section 12.—Rev. 6/98.

Corrections and Improvements

To report errors or recommend improvements to this manual, please complete the Document Evaluation Form in the appendices. Mail or fax the form to:

MiTek Machinery Division
 301 Fountain Lakes Industrial Drive
 St. Charles, MO 63301
 Attn: Engineering Manager, Fax: 636-328-9218

Notice of Change

Horizontal Stacker

Use this page to record service bulletins and notices that you receive to keep your manual updated.

Number	Date	Title

Table of Contents

Safety (English)	v
Safety Indicator Signal Words	v
General Equipment Safety Rules	vi
Lockout/Tagout	ix
Lockout/Tagout Guidelines	ix
Electrical Lockout/Tagout Procedures	x
Hydraulic Lockout/Tagout Procedure	xii
Troubleshooting with an Energized Machine	xii
Safety Test	xiii
Preparing for the Safety Test	xiii
Inspecting the Horizontal Stacker	xiii
Checking the Function of the E-Stop Pushbuttons	xiv
Restricted Zone	xv
Safety Symbol Definitions	xvi
Declaration of Safety Conformity	xxi
Seguridad (Español)	xxii
I Indicadores de seguridad: Palabras de aviso	xxii
Reglas generales de seguridad para el equipo	xxiii
Bloqueo/Etiquetado	xxvi
Pautas de bloqueo/etiquetado	xxvi
Procedimientos de bloqueo/etiquetado eléctricos	xxvii
Procedimientos de bloqueo/etiquetado hidráulicos	xxix
Solución de problemas con una máquina energizada	xxix
Prueba de seguridad	xxx
Preparativos para la prueba de seguridad	xxx
Inspeccionando el Apilador horizontal	xxx
Verificación de la función de los botones de Paro de emergencia	xxxi
Zona restringida	xxxii
Definiciones de los símbolos de seguridad	xxxiii
Declaración de conformidad de seguridad	xxxviii
Introduction	1
Introduction to the Manual	1
Purpose and Scope of This Manual	1
Understanding This Manual	1
Additional Resources	3
Website	3
Phone or E-mail Support	3
General Information	4
Introduction to the Equipment	4
Purpose of the Equipment	4
Description of the Equipment	4
Safety Compliance of the Equipment	4
System Identification	7
Main Components	7
Technical Specifications	8

Installation	9
Installation Requirements	9
Environmental Requirements	9
Infrastructure Requirements	10
Responsibilities During Installation	11
Responsibilities Before Moving or Selling	11
Start Up	12
Operation	13
Before You Begin	13
Safety Operating Notes	13
Stopping the Horizontal Stacker	14
Indicators on the Horizontal Stacker	17
Operator Controls	19
Operating the Horizontal Stacker	20
Positioning the Scanners	20
Starting the Horizontal Stacker	22
Operating the Horizontal Stacker in Manual Mode	23
Operating the Horizontal Stacker in Auto Mode	26
Using the Reset Button	28
Alternate Operator Controls	29
Using the Touch Screen	29
Using the Radio Controller	30
Maintenance	31
Maintaining Your Machine	32
Performing Maintenance Safely	33
Before Operating This Machine	33
Lockout/Tagout	34
Important Safety Information	34
Making Adjustments and Replacing Parts	36
Wearing Personal Protective Equipment	37
Testing the Safety of the Machine	37
Selected Component Overviews	38
Electrical Enclosures	38
PLC (Programmable Logic Controller)	39
HPU (Hydraulic Pressure Unit)	39
Bracing Transporters	40
Unbracing Transporters	41
Mechanical System	42
Lubricating Gear Reducers and Chains	42
Lubricating Bearings and Pins	43
Tensioning Chains	47
Adjusting the Electric Motor Brake	49
Hydraulic System	50
Hydraulic Fluid Recommendations	50
Checking Hydraulic Fluid	51
Adding Hydraulic Fluid	51
Replacing the Filter Element	52
Replacing Hydraulic Fluid	53
Verifying the Priming of the Pump	55

Adjusting Flow Control Valves	56
Electrical System	57
Setting Tip Switches	57
Setting Proximity Switches	59
Changing the Rotation of a Motor.	59
 Troubleshooting	 60
Safety Notes for Troubleshooting	60
General Troubleshooting Safety Tips	60
Electrical Troubleshooting Safety Tips	61
Getting Started with Troubleshooting.	62
Tools Required	62
First Steps	63
Identifying Problems and Solutions	64
Diagnostic Information for Troubleshooting	67
PLC Status Menu	68
Hardware Status Menu.	68
Limit Switch Conditions Menu	69
Proximity Switch Conditions Menu	70
Motor Starters Menu.	71
Solenoid Conditions Menu	72
Alarm Status Menu.	73
Alarm Menu	73
E-Stop and Power Diagnostic.	74
System Faults Menu.	75
Breaker and Motor Starter Overloads Menu.	76
 Parts List	 77
Using the Parts List Appendix.	77
Safety Notes for Replacement Parts	77
Part Numbers.	79
Mechanical Parts	79
Hydraulic Parts	79
Electrical Parts	80
Documentation Parts	80
Label Part	81
 Maintenance Checklist	 82
Using the Maintenance Checklists	82
Safety Notes for the Maintenance Checklists	82
Daily Checklist.	83
Weekly Checklist.	84
Monthly Checklist	85
 Drawing Set	 86
 Document Evaluation	 87
 Glossary	 89
 Index	 92

Safety (English)

Purpose of Chapter

This chapter explains general information and specific procedures for operating the machine safety.

Safety Indicator Signal Words

The following signal words and colors are used throughout this document to indicate safety hazards. Pay careful attention when you see them. The level of severity differs for each signal word and color.

Signal words are accompanied by graphics showing what personnel should or should not do. The graphics are called safety symbols and are defined on page xvi, but more specific text is provided every time a graphic is used throughout the manual. Everyone near the machine must be trained on how to read these safety indicators.

Failure to comply with the instructions accompanying each signal word may result in property damage, personal injury, or even death. Personnel must follow all safety procedures and practices to ensure the safest possible operation of this equipment. However, at no time is this document a substitute for common sense. Personnel must ensure that the work environment is safe and free of distractions.



Refiérase a la página xxii para español.

For safety information in Spanish, refer to page xxii.

Danger

Indicates an imminently hazardous situation which, if not avoided, is likely to result in death or serious injury.

Warning

Indicates a potentially hazardous situation, which, if not avoided, may result in death or serious injury.

Caution

Indicates a potentially hazardous situation which, if not avoided, may result in minor or moderate injury.

Notice

Calls attention to information that is significant to understanding the operation at hand or the potential for property damage.

Environmental

Applies to conditions that may affect the environment but do not have an immediate, direct effect on personnel or equipment.

General Equipment Safety Rules

Because it is impossible to anticipate every circumstance that might involve a hazard, the safety information provided in this equipment manual and on the machine is not all-inclusive. If this machine is operated or serviced using a procedure not specifically recommended by the manufacturer, the procedure shall be approved by a professional engineer to ensure it will not render the equipment unsafe. Use extreme caution and common sense at all times.

Know Your Equipment

- Read this manual completely before using or maintaining the equipment. Do not operate this machine unless you have a thorough knowledge of the controls, safety devices, emergency stops, and operating procedures outlined in this manual.
- Read and follow all safety notes. Failure to comply with these instructions may result in economic loss, property damage, and/or personal injury including death.
- Refer to the lockout/tagout guidelines on the following pages to safely perform maintenance and troubleshooting of this equipment.
- Observe and obey all safety labels. Replace worn labels immediately.
- Use this equipment solely for the purpose described in this manual.
- Only qualified personnel should attempt to operate or perform maintenance on this equipment. “Qualified personnel” is defined as:

...a person or persons who, by possession of a recognized degree or certificate of professional training, or who, by extensive knowledge, training, or experience, has successfully demonstrated the ability to solve problems relating to the subject matter and work—ANSI B30.2-1983

...one who has skills and knowledge related to the construction and operation of the electrical equipment and installations and has received safety training on the hazards involved—NEC 2002 Handbook

Personal Safety

- Always wear safety glasses and hearing protection in an industrial environment.
- Utilize a filtering face piece (dust mask) when working near sawdust.
- Wear proper clothing and appropriate personal protective equipment (e.g., safety glasses and hearing protection.) Do not wear loose clothing or jewelry. Confine long hair by tying it back.
- Use caution when lifting heavy parts or material.

Installing the Equipment

- Follow installation requirements completely. See page 9 for more information about installation requirements.
- This equipment is not for use in a residential area.

Lockout/Tagout

- Before performing maintenance on the hydraulic systems, bleed the lines to eliminate pressure.
- Lockout/tagout all energized systems before performing maintenance on them. Refer to lockout/tagout guidelines in section on page ix.



Keeping a Safe Environment

- Keep children away. All visitors should be kept a safe distance from the work area. Hazards may not be apparent to individuals unfamiliar with the machine.
- Keep work areas well lit.
- Keep the work area clean and free of any trip or slip hazards.
- Minimize dust clouds and protect your equipment by cleaning dust in this manner:
 - a) Shut down electrical power and sources of ignition

	NOTICE
	<p>Never use compressed air inside an electrical enclosure. It may force contaminants into electrical connections.</p> <p>Use a vacuum to remove dust from electrical enclosures. Canned air is acceptable after vacuuming.</p>

- b) Vacuum dust prior to blowing with air
- c) Powered cleaning equipment such as vacuums must be consistent with local governmental codes for use in dusty conditions.

Operating and Maintaining the Equipment

- Ensure that all people, tools, and foreign objects are clear of the restricted zones before operating this equipment. The restricted zones are shown on page xv.
- Perform safety tests to ensure all E-stops are working properly before operating the equipment at the initial startup, after performing any maintenance, and in accordance with the maintenance schedule.
- In case of machine malfunction, stop the machine immediately using an E-stop and report the malfunction to a supervisor.
- Never leave the machine running unattended. Turn the power off! Do not leave the machine until all parts have come to a complete stop and all electrical power has been shut off.

- Check for worn or damaged parts regularly. Repair or replace them immediately.
- Keep the hydraulic, mechanical, and electrical systems in good working order at all times. Repair leaks and loose connections immediately. Never exceed the recommended pressure or electrical power.
- Check that all safety devices are in working order before each shift starts. All protective guards and safety devices must be in place before and during use of the machine. Never disconnect or bypass any safety device or electrical interlock.
- Only qualified maintenance personnel shall remove or install safety devices.
- Periodically inspect the quality of the finished product.

Electrical Safety

- Do not use any liquids in the interior of electrical cabinets.
- When using solvents on and around the machine, remove power to the machine to eliminate the chance of sparking, resulting in explosion or fire. Wear a respirator approved for use with solvents. Wear protective clothing, gloves, and safety glasses.

Lockout/Tagout

Lockout/Tagout Guidelines

All lockout/tagout guidelines must be met according to OSHA 29 CFR 1910.147. A specific procedure should be included in your company's energy control program. This manual is not intended to replace your company's de-energizing or lockout/tagout procedure required by OSHA, but merely to provide general guidance.

The term "lockout," as used in this manual, means placing a lockout device on any and all energy sources to ensure that the energy isolating device and the equipment being controlled cannot be re-energized or operated until the lockout device is removed. The Figure 5-4 on page 16 shows where the electrical disconnects are located for this machine.

- Energy sources for this machine include electrical, mechanical, and hydraulic energy.
- In the case of electrical energy sources, power and control power to the machinery must be turned off and physically locked in the Off position.
- A lockout device is usually a keyed padlock.

If more than one person is working in a restricted zone, use a group lockout device that will allow each person to use a lock that can be removed only by the person performing the maintenance.

"Tagout" means that a prominent warning is securely fastened to an energy-isolating device to indicate that the equipment shall not be operated.

Whenever you see this symbol, lockout/tagout!

Figure 1-1: Example of a Lockout/Tagout Device



Electrical Lockout/Tagout Procedures

Working on a Machine Outside the Machine’s Main Electrical Enclosure





If you are working on the electrical transmission line to the machine, follow the procedure on page xi.

If you need to work on the transporters with the boom raised, see page 40.

Before performing maintenance on any machine with electrical power, lockout/tagout the machine properly. When working on a machine outside of the machine’s main electrical enclosure, not including work on the electrical transmission line to the machine, follow your company’s approved lockout/tagout procedures which should include, but are not limited to the steps here.

1. Engage an E-stop on the machine.
2. Turn all of the disconnect switch handles on the electrical enclosures to the Off position. Disconnect switches are shown in Figure 5-4 on page 16.

	 WARNING
	<p>ELECTROCUTION HAZARD.</p> <p>When the main or heater disconnect switch is off, there is still live power within that disconnect switch’s enclosure. Always turn off the power at the building’s power source to the equipment before opening these electrical enclosures.</p>



If installed correctly, the heater electrical enclosure is on a separate circuit from the main electrical enclosure.

3. Attach locks and tags that meet OSHA requirements for lockout/tagout to both the heater electrical enclosure and the main electrical enclosure.
4. Locate the manual override on the hydraulic pressure unit.
5. Press and hold the manual override on the valve for several seconds in one direction and then the other to bleed pressure from the lines.

Figure 1-2: Sample of a Lockout/Tagout Mechanism on an Electrical Enclosure



Working on a Machine Inside the Machine's Electrical Enclosures or in the Electrical Transmission Line to the Machine

Before opening the machine's main electrical enclosure, or attempting to repair or replace an electrical transmission line to the machine, lockout/tagout the machine properly.

Follow your company's approved lockout/tagout procedures which should include, but are not limited to the steps here.

1. Engage an E-stop on the machine.
2. Shut the power to the machine off at the machine's power source which is usually an electrical service entry panel on the facility wall. One example of a locked-out power source panel is shown in Figure 1-3.
3. Attach a lock and tag that meets OSHA requirements for lockout/tagout.
4. Open the door to the enclosure in which you need access, and using a UL-listed multimeter rated above the maximum possible voltage, verify that the power is off.

Figure 1-3: Sample of a Lockout/Tagout Mechanism on a Power Source Panel



Hydraulic Lockout/Tagout Procedure

Before attempting repair or performing maintenance on a hydraulic line or component, lockout/tagout the machine properly. Follow your company's approved lockout/tagout procedures. In addition, refer to the procedures listed here.



Table 1-1: Hydraulic Lockout/Tagout Procedures

Type of Lockout/Tagout	Page
Lockout/tagout with boom completely lowered	x
Lockout/tagout with boom raised and braced	40



Troubleshooting with an Energized Machine

Only a qualified electrician, using the personal protective equipment and following the procedures recommended in NFPA 70E should ever attempt service or repair of or near an energized area or component of the machine.

Whenever maintenance is performed while the equipment is electrically energized, there is a potential electric arc flash hazard. Refer to NFPA 70E for the personal protective equipment required when working with electrically energized components. Hydraulic components may move unexpectedly if not de-energized. Physically restrain any components capable of movement when working on or near those components.

Safety Test

This test procedure **MUST** be performed by qualified personnel at the start of each shift and after ANY maintenance, adjustment, or modification. Testing ensures that the safety system and machine control system work together to stop the machine properly.

	 DANGER
	<p>If the Horizontal Stacker fails any part of this safety test, fix the problem before proceeding to the next step.</p> <p>Operating a Horizontal Stacker that has failed any part of the safety test may result in serious physical injury or death.</p>

Preparing for the Safety Test

Before starting the Horizontal Stacker safety test, read the entire Operation chapter. The chapter starts on page 13. Make sure that you understand the locations and function of E-stops as well as the overall operation of the Horizontal Stacker.

Inspecting the Horizontal Stacker

1. Lockout / tagout the main electrical enclosure of the Horizontal Stacker.
2. Check the transporters for debris that would damage the transporter when it starts moving. The following locations are especially important:
 - between the scissor arms under the boom;
 - between the boom and the frame; and
 - between the parts of the boom.
3. Check the physical condition of the Horizontal Stacker. The following are especially important:
 - the chains should be properly tensioned according to the specifications on pages 47 and 48
 - the hydraulic hoses and cylinders should be intact without leaks.
4. Remove the lock and tag from the main electrical enclosure. Turn the disconnect switch handles on the electrical enclosure to the On position.
5. Make sure that the Horizontal Stacker has power by verifying that the power light on the main electrical enclosure is illuminated green.
6. Press the Reset button on the pushbutton enclosure.
7. Verify that the transporters are lowered and that the booms on the transporters are centered. If they are not, use the manual controls to move the transporters into position.



See page 23 for instructions on operating the transporters in manual mode.

Checking the Function of the E-Stop Pushbuttons

Some steps of this section of the safety test may require a second person.

1. Turn the selector switch on the pushbutton enclosure to Manual mode.
2. While using the manual controls to raise the transporters, press the E-stop on the pushbutton enclosure. Verify that the following happens:
 - the transporters should stop moving immediately;
 - the motors and pumps on the hydraulic pressure units should stop operating;
 - the E-stop pushbutton should illuminate; and
 - the touch screen should display the E-stop Power & Diagnostic menu, shown on page 74.
3. While the E-stop is actuated, attempt to move the Horizontal Stacker in Manual mode.
 - Verify that the Horizontal Stacker does not move.
 - Verify that the motors and pumps on the hydraulic pressure units do not operate.
 - If the Horizontal Stacker does move, immediately lockout / tagout and call MiTek Machinery Division Customer Service.
4. Reset the E-stop pushbutton by pulling it.
5. Press the Reset button on the pushbutton enclosure.
6. Lower the transporter. Repeat steps 2 through 4 using the E-stop pushbutton on the main electrical enclosure.

If necessary, use a second person to press the E-stop pushbutton on the main electrical enclosure while you use the controls on the pushbutton enclosure.
7. Repeat steps 2 through 4 using the controls on the radio controller if your Horizontal Stacker has one.
8. Begin operation.



See page 23 for instructions on operating the transporters in manual mode.

Restricted Zone



	 DANGER
	<p>Stay out of the restricted zone when equipment is in use. Serious injury or death may result if personnel are in the restricted zone.</p> <p>Always look for personnel in the restricted zone before operating equipment.</p>

Figure 1-4: Know the Restricted Zone



Safety Symbol Definitions

The safety symbols shown in this section are found throughout the manual to indicate hazards related to this machine. All personnel expected to operate or maintain this machine should be familiar with these safety symbols and their meanings.

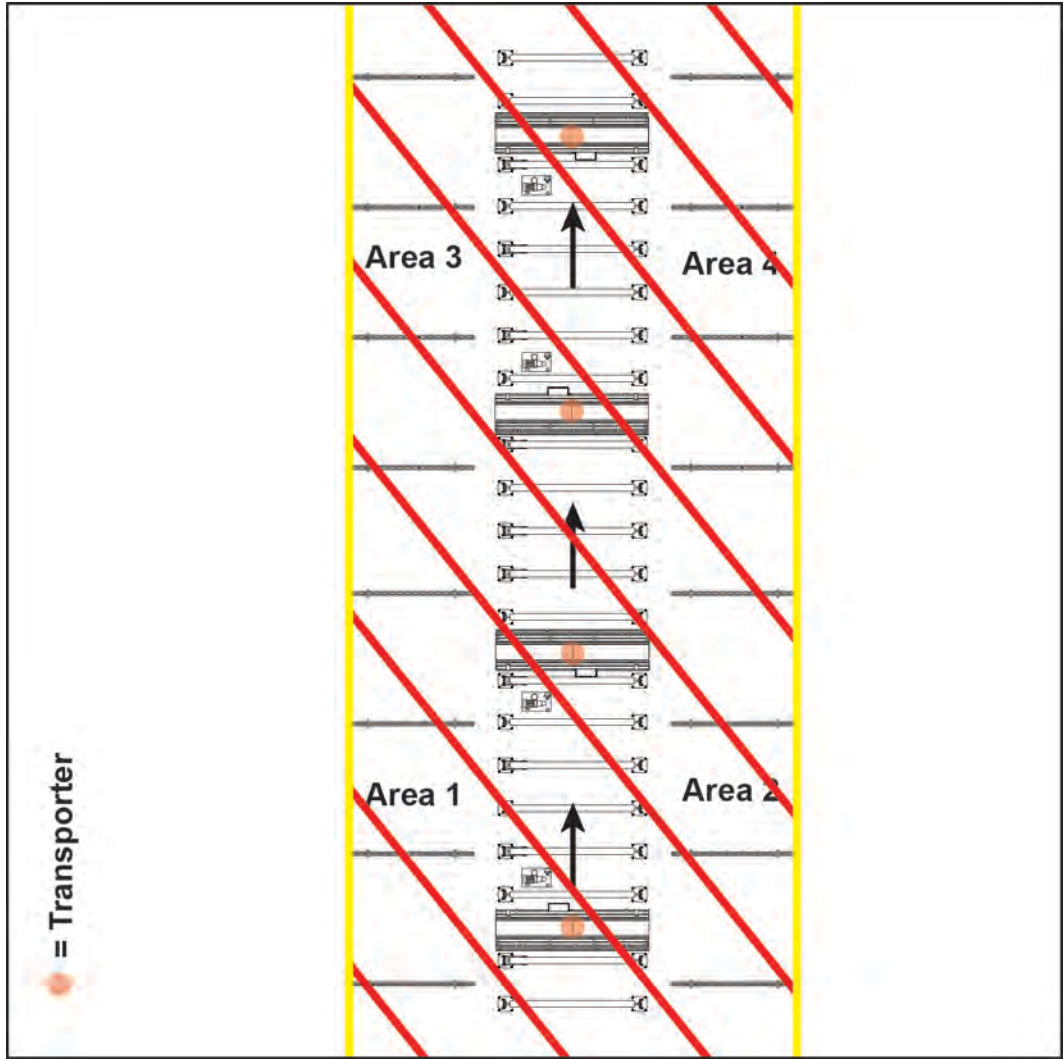

User caution. It indicates a condition where equipment damage resulting in injury could occur if operational procedures are not followed. To reduce risk of damage or injury, refer to accompanying documents, and follow all steps or procedures as instructed.



Electrical hazard. It indicates dangerous high voltages inside of an enclosure and/or the presence of a power source. To reduce the risk of fire or electric shock, do not attempt to open the enclosure or gain access to areas where you are not instructed to do so. Refer servicing to qualified service personnel only.

This equipment should be operated only from the type of source indicated on the manufacturer's identification label. Installation should be in compliance with applicable sections of the national electric code. Consult your local building code before installing.



Crush hazard. Keep hands clear.



Noise hazard. Equipment produces loud noise in excess of 100 DBA during operation. Use appropriate PPE to protect hearing when in the vicinity of this equipment.



Trip hazard. Pay attention when walking in this area.



Kickback hazard.



Keep hands and body clear.



Hot surface. Surface temperature can exceed 158°F (70°C) during normal operation. Do not touch.



Ventilate. Slots and openings in the cabinet are provided for ventilation to ensure reliable operating of the equipment. To protect the equipment from overheating, those openings must not be blocked or covered. This equipment should not be placed in a built-in installation, such as a wall cutout, unless proper ventilation is provided because hot temperatures result.



Keep feet away from moving parts.



Keep hands away from moving parts.



High pressure hose. Use appropriate PPE when working on equipment. Maintain safe pressure level at all times.



High pressure hydraulic hose. Use safe operating procedures at all times.



Use sling equipment rated for at least ___ lbs / ___ kgs when lifting this equipment.



The operation of this equipment requires the use of PPE.
Do not operate without wearing the required protective clothing.



Refer to manual. After installation, read the user's guide carefully before operating. Follow all operating and other instructions carefully.



Circuits are live. Lockout/tagout on the upstream disconnect prior to servicing.



Lockout in a de-energized state.



Lift point. In order to decrease the likelihood of damage to the equipment, use only the lift points indicated in the manual.



To reduce the risk of equipment damage or injury to personnel, maintain pressure at safe levels.



Use of lift equipment is mandatory.



Consult material safety data sheet.



Read all safety warnings and instructions before proceeding.



Unplug equipment before servicing.



Hazardous moving parts are located behind this access panel. Do not operate this equipment without all guards and covers in place.



Do not step or stand upon this equipment. Stepping or standing on this equipment may result in serious injury.



Not a step. Do not step or stand at this location.



Do not use unapproved lubricants in this equipment.



Do not discard into the municipal waste stream.

Declaration of Safety Conformity

Conforms electrically to the following:

- NFPA 79
- NEC Electrical Code
- Electrical enclosures carry UL 508A and the CUL for Canada
- Safety circuit conforms to Category 4 redundant monitoring

Conforms mechanically to the following:

- 10CFR 1910
- ANSI B 11.19

Seguridad (Español)

Objetivo del Capítulo

Este capítulo explica la información general y los procedimientos específicos para operar la máquina de manera segura.

I Indicadores de seguridad: Palabras de aviso

Las siguientes palabras junto con los colores de aviso se utilizan a lo largo de este documento para indicar riesgos de seguridad. Preste suma atención cuando los vea. El nivel de gravedad es diferente por cada palabra o color de aviso.

Las palabras de aviso van acompañadas por gráficos que muestran al personal lo que deben y no deben hacer. Los gráficos se llaman símbolos de seguridad y se definen en la página xxxiii, pero se proporciona un texto más específico cada vez que se utiliza un gráfico por todo el manual. Todas las personas que están cerca de una máquina tienen que ser capacitadas en cómo leer estos indicadores de seguridad.

No cumplir las instrucciones que acompañan cada palabra de aviso puede producir daños a la propiedad, lesiones personales e incluso la muerte. El personal debe seguir todos los procedimientos y prácticas de seguridad establecidos para asegurar el uso más seguro posible de este equipo. No obstante, en ningún caso este documento reemplaza el sentido común. El personal debe asegurarse de que el entorno de trabajo sea seguro y esté libre de distracciones.

Peligro

Indica una situación de riesgo inminente que, si no se evita, producirá la muerte o lesiones graves.

Advertencia

Indica una situación potencialmente peligrosa que, si no se evita, puede ocasionar la muerte o lesiones graves.

Precaución

Indica una situación potencialmente peligrosa que, si no se evita, puede producir lesiones menores o moderadas.

Aviso

Llama la atención a información importante para entender la operación que se desea realizar o la posibilidad de daños a la propiedad.

Medioambiente

Se aplica a condiciones que pueden afectar el entorno pero que no tienen un efecto inmediato o directo sobre el personal o el equipo.

Reglas generales de seguridad para el equipo

Debido a la imposibilidad de anticipar todas las circunstancias que podrían constituir un riesgo, la información de seguridad suministrada en este manual del equipo y sobre la máquina no es exhaustiva. Si se utiliza o realiza el mantenimiento de esta máquina utilizando un procedimiento no recomendado específicamente por el fabricante, el procedimiento deberá ser aprobado por un ingeniero profesional para asegurarse de que no afecte la seguridad del equipo. Tenga siempre mucho cuidado y sentido común.

Conozca su equipo

- Lea este manual en su totalidad antes de utilizar o mantener el equipo. No utilice esta máquina a menos que esté perfectamente familiarizado con los controles, los dispositivos de seguridad, los paros de emergencia y los procedimientos operativos que se describen en este manual.
- Lea y siga todas las notas de seguridad. El no cumplimiento de estas instrucciones podría producir pérdidas económicas, daños a la propiedad y lesiones personales, incluida la muerte.
- Refiérase a las pautas de bloqueo/etiquetado proporcionadas en las siguientes páginas para realizar el mantenimiento y solucionar problemas de este equipo en forma segura.
- Observe y cumpla con todas las etiquetas de seguridad. Cambie las etiquetas gastadas inmediatamente.
- Utilice este equipo únicamente para el propósito que se describe en este manual.
- Solo el personal calificado debe intentar utilizar o realizar el mantenimiento de este equipo. Por "personal calificado" se entiende:

...una persona o personas que, por el hecho de poseer un título o certificado de capacitación profesional reconocido o que, por sus amplios conocimientos o experiencia, han demostrado con éxito estar capacitadas para resolver problemas relacionados con el tema y el trabajo en cuestión—ANSI B30.2-1983

...una persona que posee habilidades y conocimientos relacionados con la construcción y uso de equipos e instalaciones eléctricas y que ha recibido capacitación en seguridad sobre los riesgos posibles—NEC 2002 Handbook

Seguridad personal

- Use siempre lentes de seguridad y protección auditiva en un entorno industrial.
- Utilice una máscara protectora cuando trabaje cerca de aserrín.
- Utilice ropa adecuada y equipo de protección personal apropiado (por ejemplo, lentes de seguridad y protección auditiva). No use ropa suelta ni joyas. Si tiene el cabello largo, amárrelo hacia atrás.
- Proceda con precaución cuando levante piezas o materiales pesados.

Instalación del equipo

- Siga los requisitos de instalación al pie de la letra. En la página 9 encontrará más información acerca de los requisitos de instalación.
- No utilice este equipo en zonas residenciales.

Bloqueo/Etiquetado

- Antes de realizar el mantenimiento de los sistemas hidráulicos, purgue las líneas para eliminar la presión.
- Bloquee y etiquete todos los sistemas energizados antes de realizar tareas de mantenimiento en ellos. Refiérase a la sección Pautas de bloqueo/etiquetado en la página xxvi.



Cómo mantener un entorno seguro

- Mantenga alejados a los niños. Todos los visitantes deben mantenerse a una distancia segura del área de trabajo. Los riesgos pueden no ser evidentes a las personas no familiarizadas con la máquina.
- Mantenga las áreas de trabajo bien iluminadas.
- Mantenga el área de trabajo limpia y libre de cualquier riesgo de tropiezo o resbalamiento.
- Minimice las nubes de polvo y proteja su equipo quitando el polvo de la siguiente manera:
 - a) Apague la alimentación eléctrica y todas las fuentes de ignición.

	AVISO
	<p>No utilice nunca aire comprimido dentro de una caja eléctrica. Puede forzar sustancias contaminantes hacia las conexiones eléctricas.</p> <p>Utilice una aspiradora para eliminar polvo de las cajas eléctricas. Es aceptable utilizar aire en lata después de aspirar.</p>

- b) Aspire el polvo antes de soplarlo con aire.
- c) El equipo eléctrico de limpieza como las aspiradoras debe cumplir con los códigos del gobierno local para uso en condiciones polvorientas.

Uso y mantenimiento del equipo

- Asegúrese de que no haya personas, herramientas y objetos extraños en las zonas restringidas antes de utilizar este equipo. Las zonas restringidas se indican en la página xxxii.
- Realice pruebas de seguridad para verificar que todos los Paros de emergencia funcionen adecuadamente antes de utilizar el equipo al principio de la puesta en

marcha y después de realizar cualquier tarea de mantenimiento, y de acuerdo con el calendario de mantenimiento.

- En caso de que la máquina no funcione correctamente, deténgala inmediatamente utilizando un Paro de emergencia e informe el problema a un supervisor.
- No deje nunca la máquina encendida si no está junto a ella. ¡Apáguela! No la abandone hasta que todas las piezas se detengan completamente y hasta que se haya apagado la alimentación eléctrica.
- Verifique periódicamente que no haya piezas gastadas o dañadas. Repárelas o cámbielas inmediatamente.
- Mantenga los sistemas hidráulicos, mecánicos y eléctricos en buen funcionamiento en todo momento. Repare las fugas y las conexiones sueltas inmediatamente. No exceda nunca la presión ni potencia eléctrica recomendadas.
- Verifique que todos los dispositivos de seguridad estén en buen funcionamiento antes de comenzar de cada turno. Todos los dispositivos protectores y de seguridad deben estar en su lugar antes y durante el uso de la máquina. No desconecte ni evite nunca ningún dispositivo de seguridad ni interbloqueo eléctrico.
- Solo el personal de mantenimiento calificado puede quitar o instalar los dispositivos de seguridad.
- Inspeccione periódicamente la calidad del producto terminado.

Seguridad eléctrica

- No utilice líquidos en el interior de los gabinetes eléctricos.
- Cuando utilice disolventes sobre o alrededor de la máquina, desconecte la alimentación para eliminar las probabilidades de chispas, que pueden producir una explosión o incendio. Use un respirador aprobado para el uso con disolventes. Use ropa protectora, guantes y lentes de seguridad.

Bloqueo/Etiquetado

Pautas de bloqueo/etiquetado

Deben cumplir con todas las pautas de bloqueo/etiquetado conforme a la norma OSHA 29 CFR 1910.147. El programa de control de energía de la compañía debe incluir un procedimiento específico. El objetivo de este manual no es reemplazar el procedimiento de desenergización o bloqueo/etiquetado de la compañía requerido por la OSHA, sino proporcionar pautas orientativas generales.

El término "bloqueo", según se utiliza en este manual, se refiere a la colocación de un dispositivo de bloqueo en todas las fuentes de energía para asegurar que el dispositivo aislador de energía y el equipo controlado por éste no puedan reenergizarse o utilizarse hasta que se retire dicho dispositivo. La figura 2-2 en la página xxvii muestra los lugares en los que se encuentran los interruptores de desconexión eléctrica de esta máquina.

- Las fuentes de energía para esta máquina incluyen energía eléctrica, mecánica e hidráulica.
- En el caso de fuentes de energía eléctrica, la alimentación principal y la alimentación de control a la maquinaria deben apagarse y bloquearse físicamente en la posición "Off" (Apagado).
- Por lo general, como dispositivo de bloqueo se utiliza un candado con llave.

Si hay más de una persona trabajando en una zona restringida, utilice un dispositivo de bloqueo grupal que permita a cada persona utilizar un candado que solo pueda ser retirado por la persona que realiza el mantenimiento.

"Etiquetado" significa que debe colocarse una advertencia fácil de ver en un dispositivo aislador de energía que indique que el equipo no debe utilizarse.

Siempre que vea este símbolo, ¡Bloquee/Etiquete!

Figura 2-1: Ejemplo de un dispositivo de bloqueo/ etiquetado



Procedimientos de bloqueo/etiquetado eléctricos

Cuando trabaja en una máquina fuera del gabinete eléctrico principal de la máquina



Si trabaja en la línea de transmisión eléctrica a la máquina, siga el procedimiento de la página xxviii.



Si necesita trabajar en los transportadores con la pluma levantada, vea página 40.

Antes de realizar el mantenimiento de cualquier máquina con alimentación eléctrica, bloquee y etiquete la máquina de forma adecuada. Cuando trabaje en una máquina fuera del gabinete eléctrico principal de la máquina, salvo en el caso de trabajos en la línea de transmisión eléctrica a la máquina, siga los procedimientos de bloqueo/etiquetado aprobados por la compañía, los cuales deberían incluir, entre otros, los pasos aquí indicados.

1. Coloque un Paro de emergencia sobre la máquina.
2. Coloque todos los mangos del interruptors de desconexión en el gabinetes eléctrico en la posición "Off" (Apagado). Los interruptores de desconexión se muestran en la figura 5-4 en la página 16.



Si se instala correctamente, el gabinete eléctrico de la caldera se encuentra en un circuito separado del gabinete eléctrico principal.

	 ADVERTENCIA
	<p>RIESGO DE ELECTROCUCIÓN.</p> <p>Cuando el interruptor de apagado principal o de la caldera está apagado, sigue habiendo energía dentro de este gabinete del interruptor de desconexión. Apague siempre la alimentación al equipo en la fuente de alimentación del edificio antes de abrir estos gabinetes eléctricos.</p>

3. Coloque bloqueos y etiquetas que cumplan con los requisitos de bloqueo/ etiquetado de la OSHA al gabinete eléctrico de la caldera y el gabinete eléctrico principal.
4. Localice el control manual sobre la unidad de presión hidráulica.
5. Oprima y mantenga oprimido el control manual en la válvula durante varios segundos en un sentido y luego el otro para purgar la presión de las líneas.

Figura 2-2: Ejemplo de un mecanismo de Bloqueo/Etiquetado en un gabinete eléctrico



Cuando trabaje en una máquina dentro del gabinete eléctrico principal de la máquina o en la línea de transmisión eléctrica a la máquina

Antes de abrir el gabinete eléctrico principal o intentar reparar o reemplazar una línea de transmisión eléctrica a la máquina, bloquee y etiquete la máquina en forma adecuada. Siga los procedimientos de bloqueo/etiquetado aprobados por la compañía, los cuales deberían incluir, entre otros, los pasos aquí indicados.

1. Coloque un Paro de emergencia sobre la máquina.
2. Apague la alimentación a la máquina en la fuente de alimentación, que, por lo general, es un tablero de servicio eléctrico que se encuentra en una pared de las instalaciones. En la figura 2-3 se muestra un ejemplo de panel de fuente de alimentación bloqueado.
3. Coloque un candado y una etiqueta que cumplan con los requisitos de bloqueo/etiquetado de la OSHA.
4. Abra la puerta del gabinete al que necesita acceder, y usando un multímetro homologado UL clasificado por encima del máximo voltaje posible, verifique que la alimentación está apagada.

Figura 2-3: Ejemplo de un mecanismo de Bloqueo/Etiquetado en un panel de fuente de alimentación



Procedimientos de bloqueo/etiquetado hidráulicos

Antes de intentar reparar o realizar el mantenimiento de una línea o componente hidráulico, bloquee y etiquete la máquina en forma apropiada. Siga los procedimientos de bloqueo/etiquetado aprobados por la compañía. Además, refiérase a los pasos aquí indicados.



Tabla 2-1: Procedimientos de bloqueo/etiquetado hidráulicos

Tipo de bloqueo/etiquetado	Página
Bloqueo/etiquetado con la pluma completamente bajada	xxvii
Bloqueo/etiquetado con la pluma levantada y amarrada	40



Solución de problemas con una máquina energizada

Solo un electricista calificado que utilice el equipo de protección personal y siga los procedimientos recomendados en la norma NFPA 70E debe intentar realizar tareas de reparación o mantenimiento en un área o componente energizados de la máquina o en su proximidad.

Cada vez que se realizan tareas de mantenimiento mientras el equipo está eléctricamente energizado, existe un riesgo potencial de formación de un arco eléctrico. Consulte la norma NFPA 70E para el equipo de protección personal requerido para trabajar con componentes eléctricamente energizados. Los componentes hidráulicos pueden moverse de manera imprevista si no se desenergizan. Trabe físicamente cualquier componente que pueda moverse cuando deba trabajar en ellos o en su proximidad.

Prueba de seguridad

Este procedimiento de prueba DEBE ser realizado por personal calificado al inicio de cada turno y después de CUALQUIER tarea de mantenimiento, ajuste o modificación. Las pruebas permiten comprobar que el sistema de seguridad y el sistema de control de la máquina funcionen juntos a fin de detener la máquina correctamente.

	 PELIGRO
	<p>Si el Apilador horizontal falla cualquier parte de esta prueba de seguridad, corrija el problema antes de proceder al siguiente paso.</p> <p>Operar un Apilador horizontal que ha fallado cualquier parte de la prueba de seguridad podría resultar en una lesión grave o la muerte.</p>

Preparativos para la prueba de seguridad

Antes de comenzar la prueba de seguridad del Apilador horizontal, lee el capítulo completo de Operaciones. Este capítulo empieza en la página 13. Asegúrese que entienda las ubicaciones y función de los Paros de emergencia igual que la operación global del Apilador horizontal.

Inspeccionando el Apilador horizontal

1. Bloquee/etiquete el gabinete eléctrico del Apilador horizontal.
2. Revise los transportadores por desechos que dañarían el transportador cuando empiecen a moverse. Los siguientes lugares son especialmente importantes:
 - entre los brazos de tijera debajo de la pluma;
 - entre la pluma y el armazón; y
 - entre las piezas de la pluma.
3. Revise la condición física del Apilador horizontal. Lo siguiente es especialmente importante:
 - las cadenas deben de estar correctamente tensionadas según las especificaciones en las páginas 47 y 48
 - las mangueras hidráulicas y cilindros deben estar intactos, sin fugas.
4. Quite el candado y la etiqueta desde el gabinete eléctrico principal. Coloque los mangos del interruptor de desconexión en el gabinete eléctrico en la posición "On" (Encendido).
5. Asegúrese que el Apilador horizontal tenga corriente al verificar que la luz de alimentación muestra verde en el gabinete eléctrico principal.
6. Oprima el botón "Reset" (Restablecer) en el gabinete de botones.
7. Verifique que los transportadores se han bajado y que las plumas en los transportadores están centradas. Si no, use los controles manuales para mover los transportadores en su posición.



Vea la página 23 para instrucciones de operación para los transportadores en modo manual.

Verificación de la función de los botones de Paro de emergencia

Algunos pasos de esta sección de la prueba de seguridad podrán requerir una segunda persona.

1. Mueva el interruptor selector situado en el gabinete de botones al modo Manual.
2. Mientras usa los controles manuales para levantar los transportadores, oprima el Paro de emergencia en el gabinete de botones. Verifique que suceda lo siguiente:
 - los transportadores deben dejar de moverse de inmediato;
 - los motores y bombas en las unidades de presión hidráulica deben dejar de funcionar;
 - el botón de Paro de emergencia debe de iluminarse; y
 - la pantalla táctil debe mostrar el menú de Alimentación y Diagnóstico del Paro de emergencia, que se muestra en la página 74.
3. Mientras el Paro de emergencia está activado, intente mover el Apilador horizontal al modo Manual.
 - Verifique que el Apilador horizontal no se mueva.
 - Verifique que los motores y bombas en las unidades de presión hidráulica no estén funcionando.
 - Si el Apilador horizontal se mueve, bloquee y etiquete de inmediato, y llame al Servicio a clientes de la División de maquinaria de MiTek.
4. Reestablezca el botón de Paro de emergencia al jalarlo.
5. Oprima el botón "Reset" (Restablecer) en el gabinete de botones.
6. Baje el transportador. Repita los pasos 2 al 4 usando el botón del Paro de emergencia en el gabinete eléctrico principal.

Si es necesario, utilice una segunda persona para oprimir el botón del Paro de emergencia en el gabinete eléctrico principal mientras usa los controles en el gabinete de botones.
7. Repita los pasos 2 al 4 usando los controles en el controlador por radio si su Apilador horizontal lo tiene.
8. Comienza la operación.



Vea la página 23 para instrucciones de operación para los transportadores en modo manual.

Zona restringida



	 PELIGRO
	<p>Manténgase alejado de la zona restringida cuando el equipo está en uso. Pueden producirse lesiones graves o incluso la muerte si el personal está en la zona restringida.</p> <p>Siempre observe que no haya personal en la zona restringida antes de operar el equipo.</p>

Figura 2-4: Conocer la zona restringida



Definiciones de los símbolos de seguridad

Los símbolos de seguridad que se muestran en esta sección se pueden encontrar en todo el manual para indicar riesgos que están relacionados a esta máquina. Todo el personal que tiene que operar o dar mantenimiento a esta máquina debe familiarizarse con estos símbolos de seguridad y lo que significan.

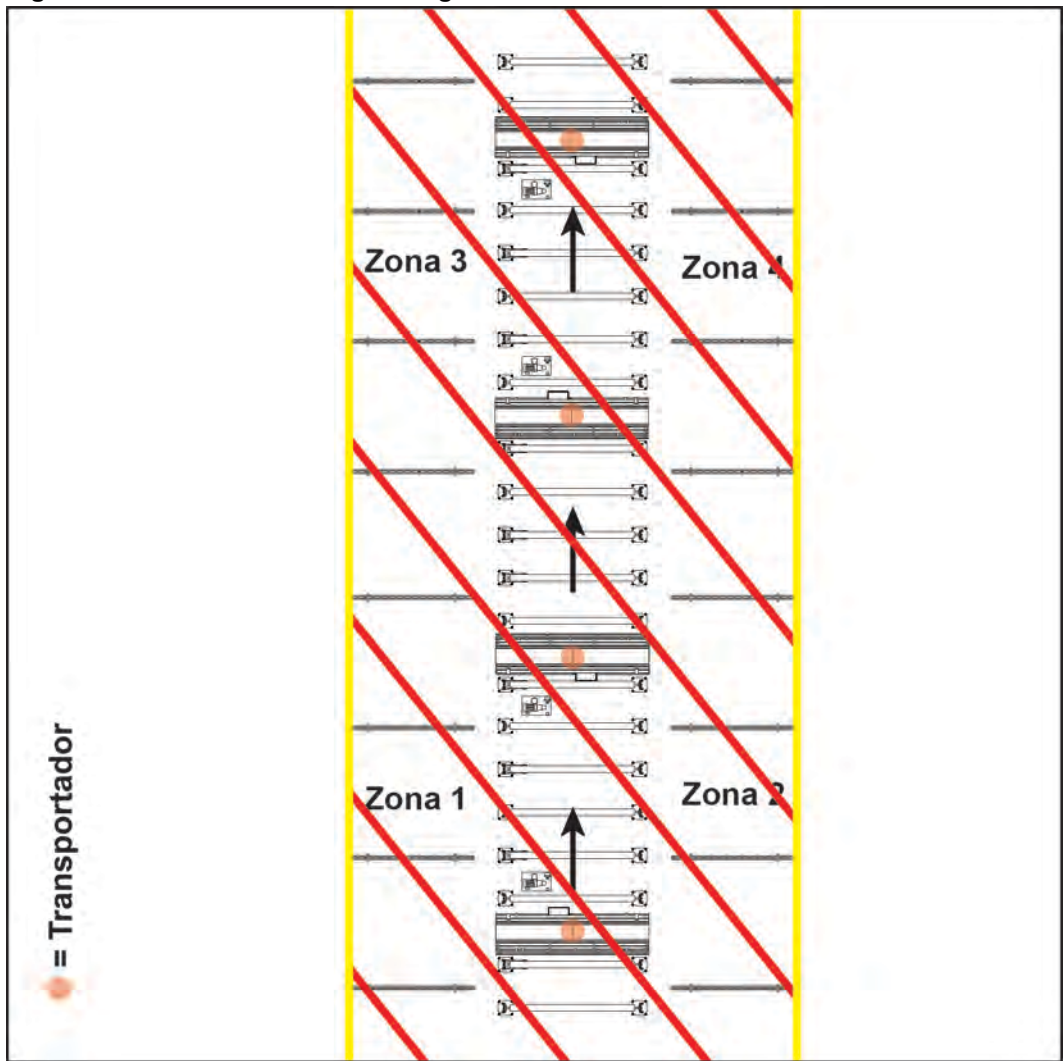

Precaución para el usuario. Indica una condición en la cual podría ocurrir un daño al equipo que cause una lesión si no se siguen los procedimientos operativos. Para reducir el riesgo de daños o lesiones, lea los documentos acompañantes, y siga todos los pasos o procedimientos que se indican.



Peligro eléctrico. Indica alto voltaje peligroso dentro de un gabinete y/o la presencia de una fuente de alimentación. Para reducir el riesgo de incendio o choque eléctrico, no intente abrir el gabinete o intente ingresar en áreas donde se le han indicado que no debe ingresarse. Solo el personal de servicio calificado debe dar servicio.

Este equipo se debe operar solo con el tipo de fuente indicado en la etiqueta de identificación del fabricante. La instalación debe de cumplir con las secciones aplicables del código nacional de electricidad. Consulte su código local de construcción antes de instalarlo.



Riesgo de aplastamiento. Mantenga las manos lejos.



Peligro de ruido. El equipo produce ruido fuerte de más de 100 dBA durante su operación. Use el equipo de protección personal para proteger la audición cuando se encuentra cerca de este equipo.



Peligro de tropiezo. Ponga atención al caminar en el área.



Riesgo de rebote.



Mantenga las manos y el cuerpo lejos.



Superficie caliente. La temperatura de la superficie puede exceder los 158°F (70°C) durante la operación normal. No tocar.



Ventilar. Las ranuras y aberturas en el gabinete se proporcionan para ventilar y asegurar la operación confiable del equipo. Para proteger el equipo de sobrecalentarse, estas aberturas no deben estar bloqueadas o tapadas. Este equipo no debe de ubicarse en una instalación cerrada, como una abertura en la pared, a menos que se haya proporcionado ventilación adecuada ya que dará como resultado temperaturas altas.



Mantenga los pies lejos de las piezas en movimiento.



Mantenga las manos lejos de las piezas en movimiento.



Manguera de alta presión. Use el equipo de protección personal cuando trabaje en el equipo. Mantenga un nivel seguro de presión en todo momento.



Manguera hidráulica de alta presión. Usa el procedimiento seguro de operación en todo momento.



Utilice el equipo de cabestrante calificado para por lo menos ___ lb / ___ kg al levantar este equipo.



La operación de este equipo requiere el uso de equipo de protección personal.

No operar sin ponerse la ropa protectora requerida.



Refiérase al manual. Después de la instalación, lea la guía de usuario cuidadosamente antes de operar el equipo. Siga todas las instrucciones de operación y otras cuidadosamente.



Los circuitos tienen corriente. Bloquee/etiquete en la desconexión de flujo arriba antes de darle servicio.



Bloqueo en un estado desenergizado.



Punto de levantamiento. Para reducir la probabilidad de daño al equipo, utilice solo los puntos de levantamiento indicados en el manual.



Para reducir el riesgo de daño al equipo o lesiones al personal, mantenga la presión a niveles seguros.



El uso de equipo de levantamiento es obligatorio.



Consulte la hoja de datos de seguridad de materiales.



Lea todas las advertencias de seguridad e instrucciones antes de continuar.



Desenchufe el equipo antes de darle servicio.



Las piezas en movimiento peligrosas están ubicadas detrás de este panel de acceso. No opere este equipo a menos que todos los dispositivos protectores y cubiertas estén en su lugar.



No pise ni se pare en este equipo. Pisar o parar en este equipo puede resultar en una lesión grave.



No es un escalón. No pise ni se pare en esta ubicación.



No utilice los lubricantes no aprobados en este equipo.



No deseche con los residuos municipales.

Declaración de conformidad de seguridad

Es conforme eléctricamente a lo siguiente:

- NFPA 79
- El código eléctrico NEC
- Los gabinetes eléctrico conllevan UL 508A y el CUL para Canadá
- El circuito de seguridad es conforme a la Categoría 4 de monitoreo redundante

Es conforme mecánicamente a lo siguiente:



- 10CFR 1910
- ANSI B 11.19

Introduction

Purpose of Chapter

This chapter explains how to navigate through the manual and how to contact MiTek Machinery Division Customer Service.

Introduction to the Manual

	 WARNING
	<p>Read this manual completely before using this equipment.</p> <p>Do not operate this equipment until you have a thorough understanding of all controls, safety devices, emergency stops, and operating procedures outlined in this manual.</p> <p>All hazard instructions must be read and observed. Failure to do so may result in economic loss, property damage, and/or personal injury.</p> <p>This manual must always be available to personnel.</p>

Purpose and Scope of This Manual

In order for this manual to be useful, it must be accessible.

This manual addresses the most recent version of the Horizontal Stacker as of the date listed on the title page. For earlier revisions, contact MiTek Machinery Division Customer Service.

This manual is a valuable training tool.

- The *Introduction* and *General Information* chapters discuss contact information for MiTek and provide basic information about the equipment.
- The *Operation* chapter teaches operators how to efficiently operate the machine.
- The *Maintenance* chapter details procedures specifically for maintenance personnel.
- The appendices provide valuable training materials and technical information to keep your equipment running.

Understanding This Manual





Drawing Set

A drawing set is included in a folder accompanying this manual. The drawings assist with troubleshooting and ordering replacement parts. A list of the drawings included in the drawing set can be found on page 86.

Navigational Aids

The graphics used in Table 1-1 are used throughout the manual to communicate a specific type of information quickly.

Table 1-1: Navigational Aids

Graphic	Explanation
	<p>This icon is an important safety note.</p> <p>It indicates that you must lockout/tagout at the appropriate disconnect switch using approved methods described in OSHA CFR 1910.147 before continuing with the procedure.</p>
	<p>This icon specifies that certain tools are needed before a procedure begins.</p>
	<p>This icon provides additional information to supplement the main text.</p>
	<p>This icon indicates how to locate additional relevant information or resources.</p>

Formatting Cues

In this manual, some procedures involve interacting with a computer. These procedures include text with specific formatting.

Table 1-2: Formatting Cues for Instructions on a Computer

Text Appearance	Indication	Example
Initial cap and bold text	Key on keyboard or button on screen	Press Enter
Initial cap and italic text	Menu or field that you must find or select	Click the <i>File</i> menu
Lowercase letters and no italics	Menu, field, or virtual button referenced	While in the main menu
Plus (+)	Hold buttons at the same time	CTRL+ALT+DELETE
Greater than (>)	Next selection, often used in file paths	<i>File > Open</i>

Additional Resources

Website

Visit the MiTek website at www.mitek-us.com for up-to-date information on all MiTek equipment. You may also find the following information there:

- The latest revisions of this manual
- Service bulletins pertaining to your equipment
- Support, safety, and training information
- Part numbers for ordering parts

Phone or E-mail Support

To obtain expert technical assistance or to order parts, contact MiTek Machinery Division Customer Service using one of the following methods.

Table 1-3: Contact Information

<p>MiTek Machinery Division Customer Service Department 301 Fountain Lakes Industrial Drive St. Charles, MO 63301</p> <p>Parts Orders (with part number) E-mail: mitekparts@mii.com</p> <p>Technical Assistance Phone: 800-523-3380 Fax: 636-328-9218 machinerysupport@mii.com</p> <p>Website www.mitek-us.com</p>	
--	---

General Information

**Purpose
of Chapter**

This chapter provides an overview of the equipment and the means to identify it.

Introduction to the Equipment

Purpose of the Equipment

The Horizontal Stacker removes trusses from Stand-Alone Conveyors and stacks them horizontally nearby.

Description of the Equipment

Horizontal Stackers integrate with Stand-Alone Conveyors to move trusses from the conveyors to stacks on the side. Horizontal Stackers are available in two configurations.

- A two-area Horizontal Stacker places trusses in two locations. Figure 2-1 on page 5 shows the two areas of this configuration.
- A four-area Horizontal Stacker places trusses in four locations. Figure 2-2 on page 6 shows the four areas of this configuration.

See Table 2-3 on page 7 for additional details about the specific components of a Horizontal Stacker system.

Safety Compliance of the Equipment

Equipment shipped to a U.S. destination is compliant NFPA 79, NEC 2009, and applicable OSHA regulations. This manual covers the U.S. version of the Horizontal Stacker.

Figure 2-1: Horizontal Stacker (Two-Area System)

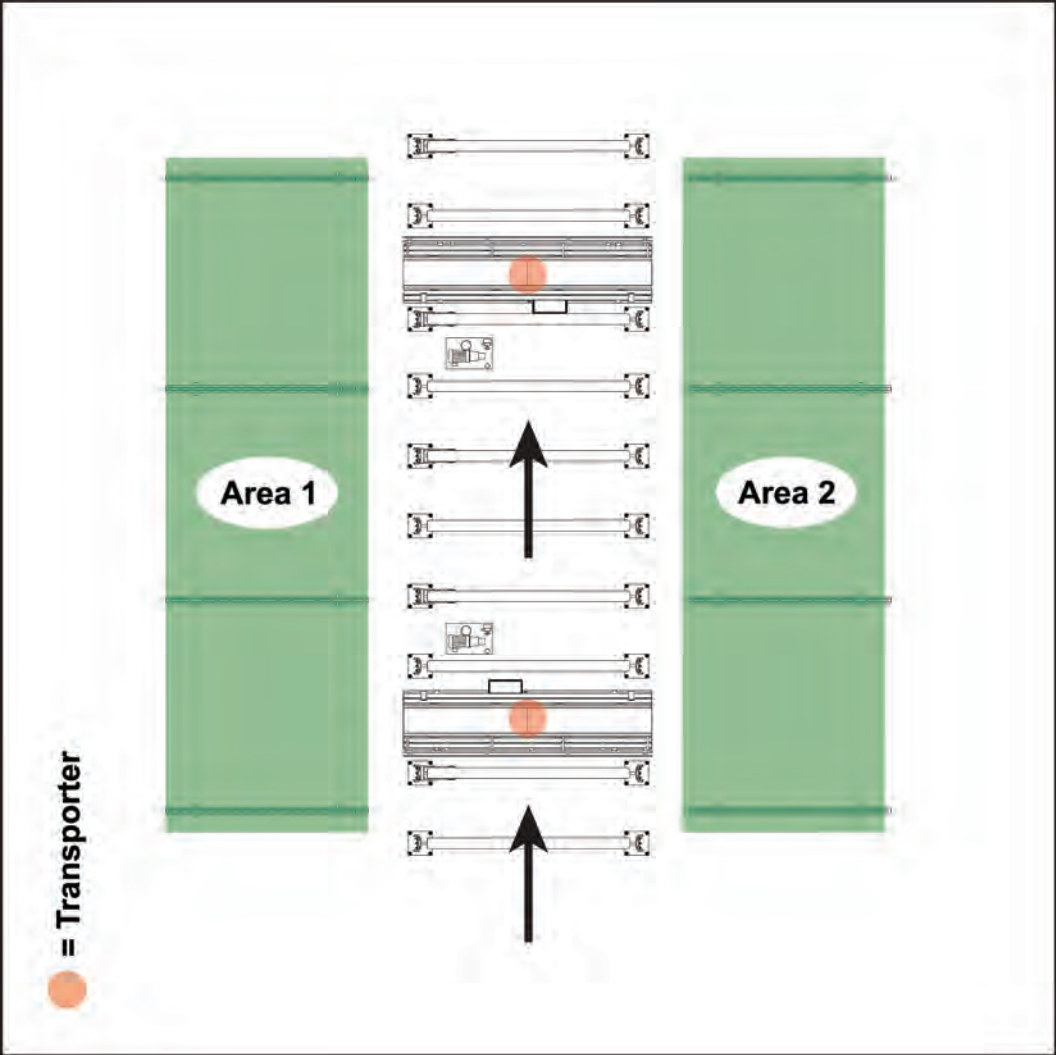
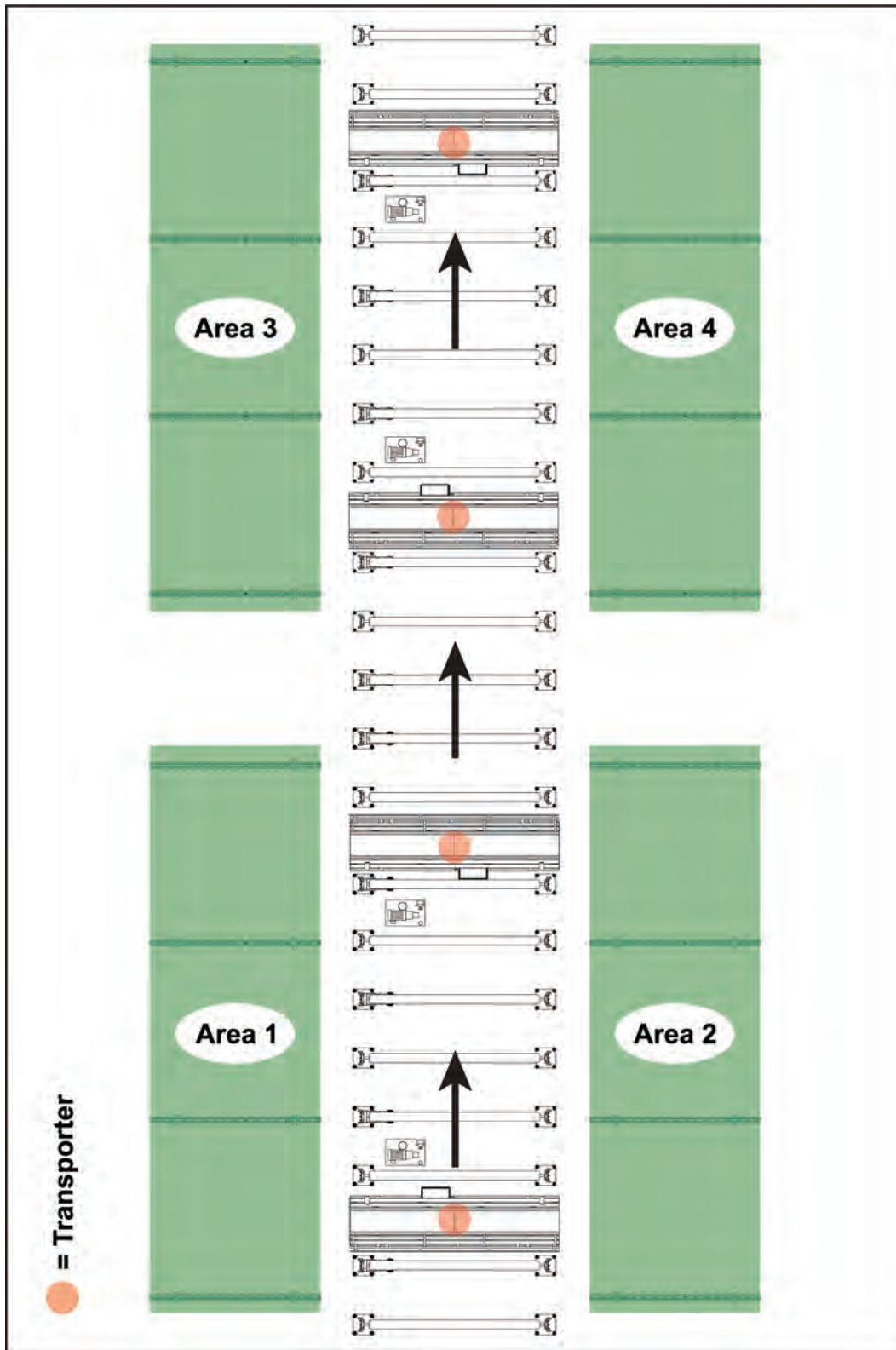

Figure 2-2: Horizontal Stacker (Four-Area System)



System Identification

Table 2-1: Top-Level Part Numbers

Part	Areas	Part Number
Horizontal Stacker mechanical assembly	Two	70300-501



See page 86 for a list of drawings included with the Horizontal Stacker.

Table 2-2: Top-Level Part Numbers

Part	Areas	Part Number
Horizontal Stacker electrical assembly	Two	90436-520-xxxV
Horizontal Stacker electrical assembly	Four	90436-540-xxxV

Main Components

Table 2-3 lists some of the main components that are included with all versions of the Horizontal Stacker.

Table 2-3: Main Components

Component	Description	Part Number
Transporter	A lift equipped with hydraulic cylinders that lift a truss above the Stand-Alone Conveyors and with a boom that moves the truss over receiver stands	70300-501
Scanner	A device that detects the presence of a truss as it passes on the Stand-Alone Conveyors and signals the transporters to start moving	70560
Traffic cop	A device that prevents collisions between a truss and a transporter by pausing the Finish Roller, Stand-Alone Conveyors, or both when the transporter is moving	70530
Receiver stands	Stands consisting of horizontal rails that keep trusses elevated and vertical poles that keep them from shifting	70575
Radio controller	A handheld device that operates the system in the same way as the pushbutton enclosure (includes radio controller, receiver, antenna, battery pack, etc.)	477167

Technical Specifications

Table 2-4: Approximate Capacities

Specification	Technical Data
Maximum truss weight (pounds)	400 lbs per transporter
Cycle time	35 sec.
Minimum truss length	18'
Maximum truss height	16'
Maximum truss length (two-area system)	40'
Maximum truss length (four-area system)	80'

Table 2-5: Approximate Dimensional Specifications

Component	Length	Width	Height
Transporter (retracted)	18' 7"	4' 3"	2' 4"
Transporter (extended)	28' 9"	4' 3"	6' 3"
Hydraulic unit	3' 6"	2'	2' 3"

Table 2-6: Approximate Weight Specifications

Component	
Transporter	5000 lbs
Hydraulic unit	1200 lbs

Table 2-7: Approximate Hydraulic Specifications

Pump Specification (per pump)	Technical Data
Maximum continuous operating pressure	2610 psi
Displacement	1.37 in ³ /rev
Flow	10.47 gpm
Fluid Specification	Technical Data
See Table 6-2 on page 50	

Installation

Purpose of Chapter

This chapter provides a brief overview of the responsibilities in the installation process.

Installation Requirements

Environmental Requirements

Operating Temperature

The Horizontal Stacker operates properly in ambient temperatures up to 122 degrees Fahrenheit (50 degrees Celsius).

In environments where the temperature reaches below 60 degrees Fahrenheit (15 degrees Celsius), MiTek recommends leaving the hydraulic tank heaters on continuously. The heaters prevent the hydraulic fluid from becoming too viscous.

In extremely hot environments, adding a cooler to the hydraulic unit may improve function.

Relative Humidity

The Horizontal Stacker operates properly in an atmosphere with 45 to 85 percent relative humidity.

Transportation and Storage

The Horizontal Stacker withstands or has been protected against transportation and storage temperatures from -13 to 158 degrees Fahrenheit (-25 to 70 degrees Celsius). It has been packaged to prevent damage from the effects of normal humidity, vibration, and shock.

	ENVIRONMENTAL
	<p>Do not discard machinery into the municipal waste stream.</p>

Infrastructure Requirements

Flooring Requirements

The Horizontal Stacker transporters need to be installed on pads made of 3500 PSI concrete that is a minimum of 18" thick. The pad needs to be level within 1/2" across the area of installation.

Electrical Requirements

Requirements for the electrical system of the Horizontal Stacker are detailed in Table 3-1. Note that amperage requirements vary for two-area systems and four-area systems.

Table 3-1: Electrical System Requirements for a Two-Area System

	208VAC	230VAC	460VAC
FLA plus controls	63.2 A	59.2 A	32.2 A
Disconnect fuses	70 A	70 A	35 A
Cycles	60	60	60
Phases	3	3	3

Table 3-2: Electrical System Requirements for a Four-Area System

	208VAC	230VAC	460VAC
FLA plus controls	126.4 A	118.4 A	64.4 A
Disconnect fuses	150 A	150 A	70 A
Cycles	60	60	60
Phases	3	3	3



If installed correctly, the heater electrical enclosure is on a separate circuit from the main electrical enclosure.

Hydraulic Requirements



- A two-area Horizontal Stacker requires approximately 90 gallons of hydraulic fluid.
- A four-area Horizontal Stacker requires approximately 180 gallons of hydraulic fluid.

See Table 6-2 on page 50 for hydraulic fluid specifications.

Responsibilities During Installation

MiTek supervises installation to ensure that the Horizontal Stacker system is installed properly and operates correctly. MiTek also provides operating and maintenance training at the time the equipment is installed. The customer is responsible for providing all labor and equipment needed to complete the installation.

Responsibilities Before Moving or Selling

	 WARNING
	<p>Call MiTek Machinery Division Customer Service before moving the system.</p> <p>Moving the system without proper planning may result in equipment damage or serious injury.</p>

If you determine that you want to move your Horizontal Stacker system to another location or you want to sell your system to another company, please call MiTek Machinery Division Customer Service. Customer service provides detailed information that is needed before installing the system elsewhere.





Machinery
Division
Customer Service
is available at
800-523-3380
Monday through
Friday.

Start Up

Purpose of Chapter

This chapter lists procedures required before operating your equipment.

Startup Procedures

	 WARNING
	<p>Do NOT attempt to start the system without a MiTek representative present.</p> <p>Starting the system without a MiTek representative present may result in equipment damage, serious injury, and/or death.</p>

Before your Horizontal Stacker operates for the first time, these procedures are performed. See Table 4-1 to determine MiTek's responsibilities and your responsibilities.

Table 4-1: Procedures Performed Prior to Starting the Horizontal Stacker

Procedure	Responsibility	Page
Verify that Stand-Alone Conveyors are installed properly	Customer	—
Mount electrical enclosures	Customer	—
Anchor transporters and hydraulic units	MiTek / customer	—
Connect electrical wires	Customer	—
Connect hydraulic hoses	MiTek / customer	—
Mount bars and plates for traffic cop and scanners	MiTek / customer	—
Install traffic cop and scanners	MiTek / customer	—
Supply hydraulic fluid	Customer	50
Fill hydraulic tank after tank is placed	MiTek / customer	—
Test for function and make adjustments	MiTek	—
Complete safety tests, including E-stop function	MiTek	xiii

If you decide to move your Horizontal Stacker or sell it to another company, please contact MiTek Machinery Division Customer Service. Customer service provides information that is important for removing and reinstalling the system.









Operation

Purpose of Chapter

This chapter describes operating mechanisms on this machine and the procedure to operate it in most circumstances.

Before You Begin

Safety Operating Notes

	 WARNING
	<p>ELECTROCUTION, HIGH PRESSURE, AND CRUSH HAZARDS.</p> <p>Read this section AND the safety section in the preliminary pages before operating or maintaining this machine.</p> <p>Do not operate this machine until you have a thorough understanding of all controls, safety devices, E-stops, and operating procedures outlined in this manual.</p> <p>Read and observe all warnings. Failure to do so may result in economic loss, property damage, and/or personal injury.</p> <p>This manual must always be available to personnel operating and maintaining this machine.</p>
	 WARNING
	<p>CRUSH HAZARD.</p> <p>Before turning on the machine, make sure that all personnel and other machines are out of the restricted zone (see page xv).</p>
	 WARNING
	<p>Do not operate this machine unless all guards and safety devices are in place.</p> <p>Only qualified maintenance personnel shall repair, remove, or replace guards and safety devices.</p>
	 WARNING
	<p>The operation of this machine requires the use of PPE. Do not operate without wearing safety glasses and hearing protection.</p> <p>Operating this machine without proper PPE may result in injury.</p>

Stopping the Horizontal Stacker

Stop the Horizontal Stacker in one of three ways:

- push the E-stop pushbuttons on the main enclosure or the pushbutton enclosure;
- push an E-stop pushbutton on an interlocked machine; or
- push the Stop button on the optional radio controller when the radio controller is on.

Use E-stops only in emergencies. Using the E-stop to stop the Horizontal Stacker regularly causes excessive wear. Use the Stop button on the radio controller for normal operation.

Figure 5-1: Stop Button Locations

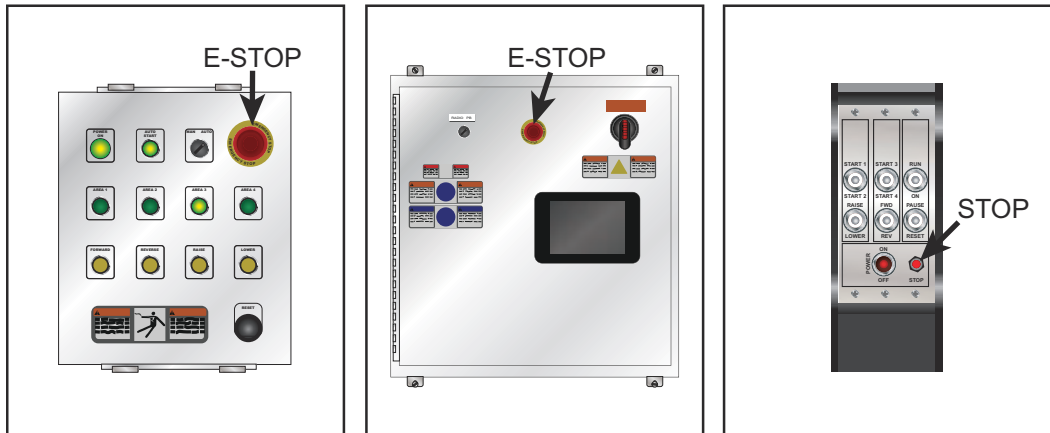

Note: the above graphics are not drawn to scale.

Operating the E-Stop Pushbuttons on Electrical Enclosures

An E-stop pushbutton is shown in Figure 5-2. To activate an E-stop pushbutton, push the button in. The Horizontal Stacker immediately stops operating.

To release an E-stop, pull the pushbutton. It returns to its extended position. The machine does not operate until the Reset button on the enclosure is pressed.

Figure 5-2: E-Stop Pushbutton on Pushbutton Enclosure

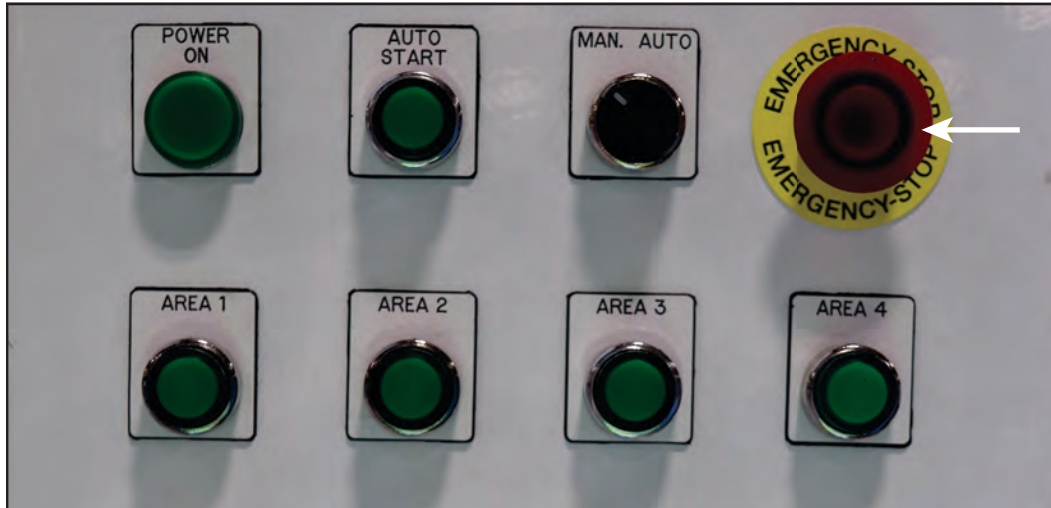

Operating the Stop Button on the Optional Radio Controller

The Stop button on the optional radio controller is shown in Figure 5-3. To activate this Stop button, push the button in.

The machine does not operate until power to the radio controller is cycled.

Figure 5-3: Stop Button on Radio Controller



Operating Disconnect Switches

Turning the disconnect handles on the main electrical enclosure and motor electrical enclosure(s) to the On position supplies electrical power to the Horizontal Stacker, except for the hydraulic fluid heaters. To remove power, turn all disconnect handles to the Off position. Figure 5-4 shows the location of disconnect switches.

While the Horizontal Stacker is not in use, MiTek recommends the following:

- The disconnect handles on the main electrical enclosure and the motor electrical enclosure(s) should be turned off.
- The disconnect handle on the heater electrical enclosure should be turned on to supply electricity to the thermostat and heater.



The thermostat and heater keep hydraulic fluid at the right viscosity when temperature drops.

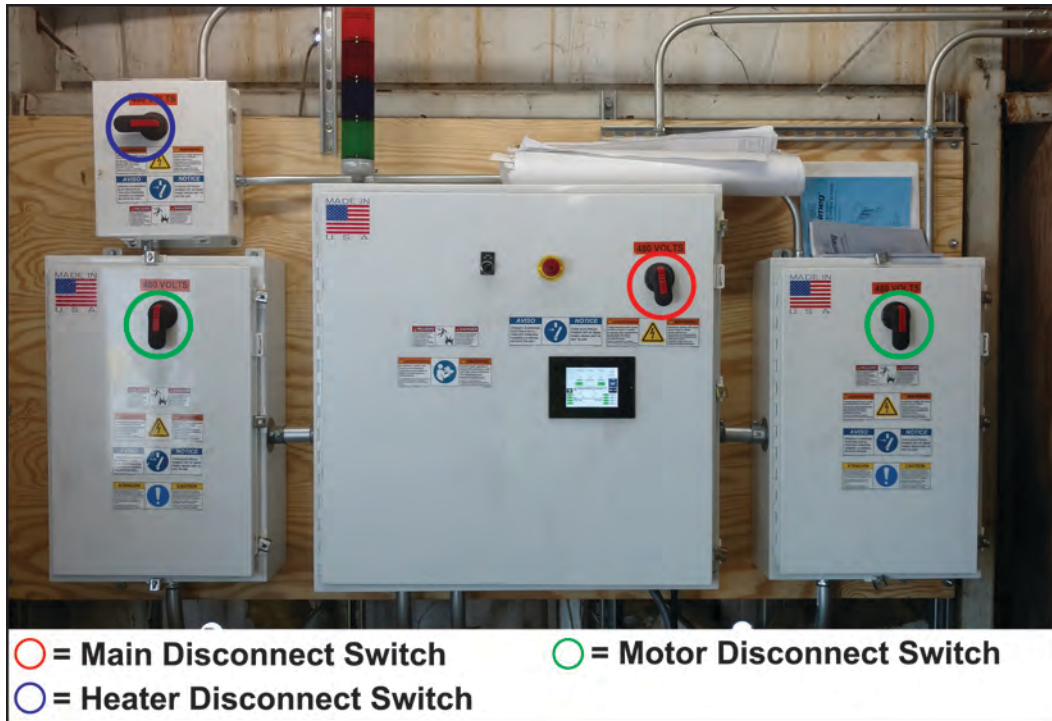

If installed correctly, the heater electrical enclosure is on a separate circuit from the main electrical enclosure.

Figure 5-4: Disconnect Switches on Electrical Enclosures



 WARNING	
	Even when the main electrical enclosure disconnect switch is turned to the Off position, there is still live power to the enclosure. This live power may cause severe electric shock.
	Always turn off power at the upstream power source before opening an electrical enclosure.

Indicators on the Horizontal Stacker

Pushbutton Enclosure Lights

The pushbutton enclosure on the Horizontal Stacker features some buttons that illuminate when pressed.

- The Power On button illuminates when the system has power.
- The Auto Start button illuminates when the transporters are operating in auto mode.
- Each area button flashes when that area is selected and turns solid when transporters operate in that area.

See Figure 5-5 for an example of a pushbutton enclosure stacking a truss in area 3 while in auto mode.

Figure 5-5: Pushbutton Enclosure with Illuminated Lights

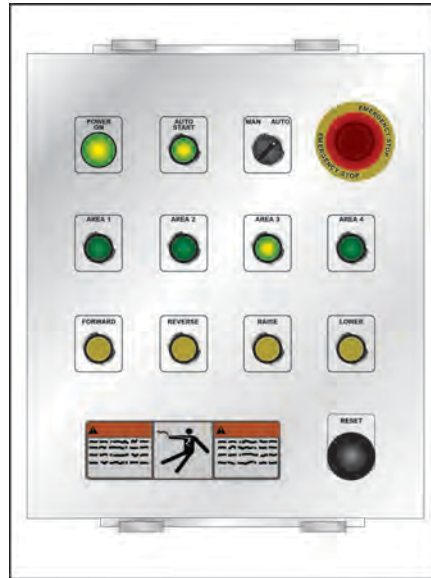

Light Stack

The Horizontal Stacker features a light stack on the main electrical enclosure.

A light in the stack flashes when an area is selected and turns solid when transporters are operating in that area.

See Figure 5-6.

Figure 5-6: Light Stack

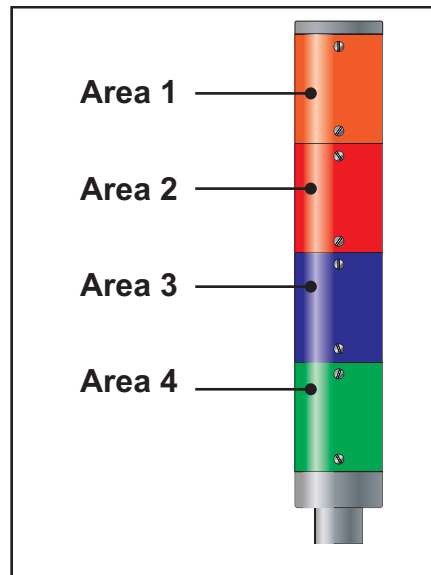

Scanner Lights

The scanners on the Horizontal Stacker detect the presence of a truss as it moves into position over the transporters. A light on the scanners flashes when one of its areas is selected. The light turns solid when one of its areas is active. See Figure 5-7.

Figure 5-7: Scanner Light



Operator Controls

Three sets of operator controls may be used to operate the Horizontal Stacker. The controls are shown in Table 5-1. The operating procedure in this chapter assumes use of the controls on the pushbutton enclosure.

Table 5-1: Operator Controls

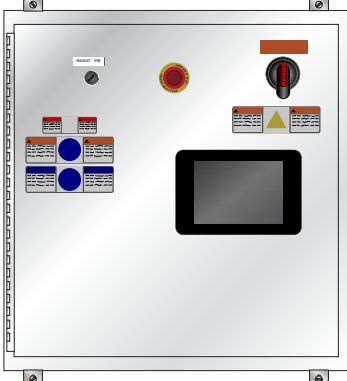
Standard / Optional	Control Method	Image
Standard	Pushbutton enclosure	
Standard	Touch screen	
Optional	Radio controller	

Operating the Horizontal Stacker

This manual only addresses the use of the Horizontal Stacker. It does not address methods of designing, building, or transporting a truss.

Positioning the Scanners

Before starting the Horizontal Stacker, make sure that the scanners are properly positioned. The proper positioning of the scanner depends on the size of a particular truss and the direction its bottom chord faces in the stack.

Positioning the Scanner Based on the Position of the Truss

The scanner should always be placed on the same side as the bottom chord of the truss it is stacking. See Figure 5-8 for an example.

Figure 5-8: Example of Scanner Positioning

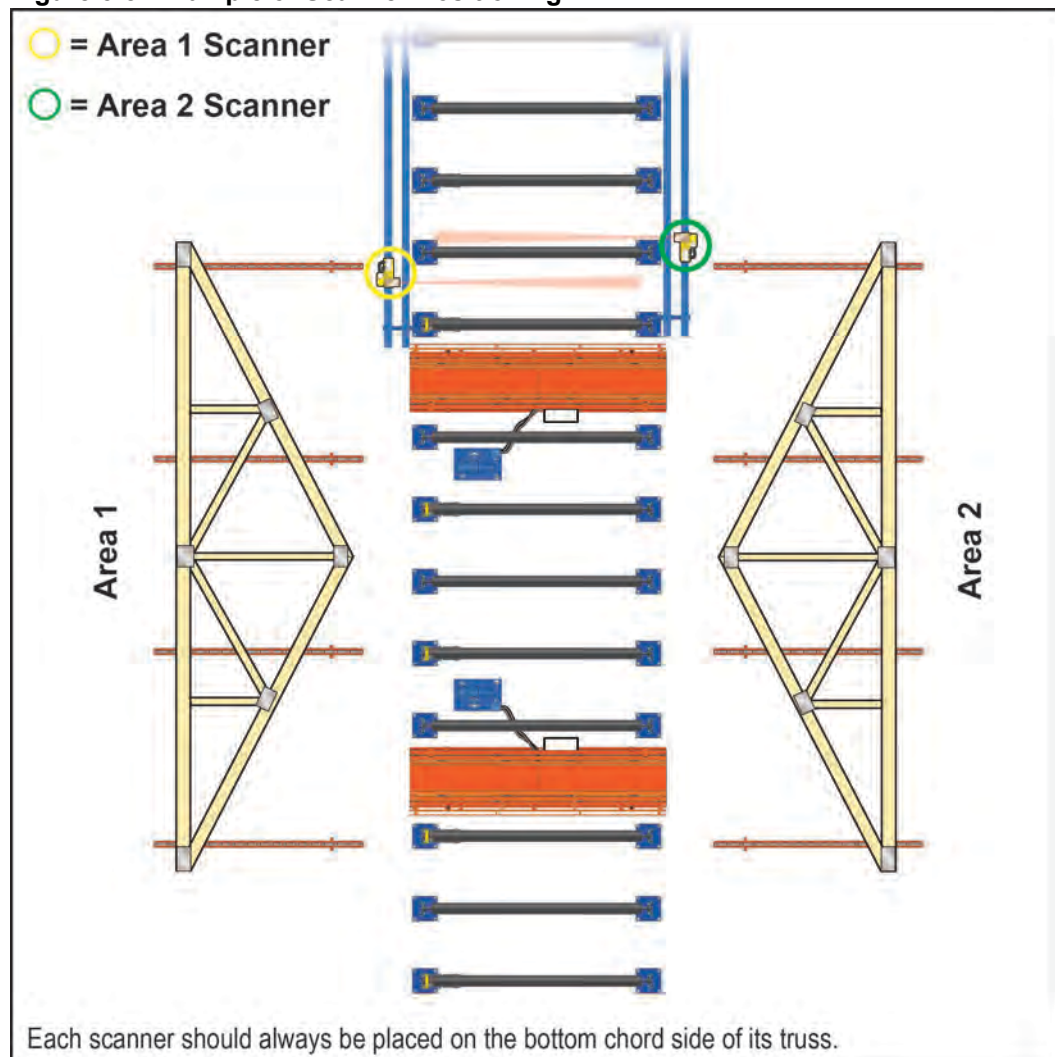

Positioning the Scanner for the Length of Truss

The scanner mounts are attached to rails and slide on the rails to adjust for the length of the truss.

Adjust the scanner mounts so that the leading edge of the truss reaches the scanner at roughly the same time the truss is centered over its transporters. See Figure 5-9.

Figure 5-9: Scanner Positioning for Length of Truss

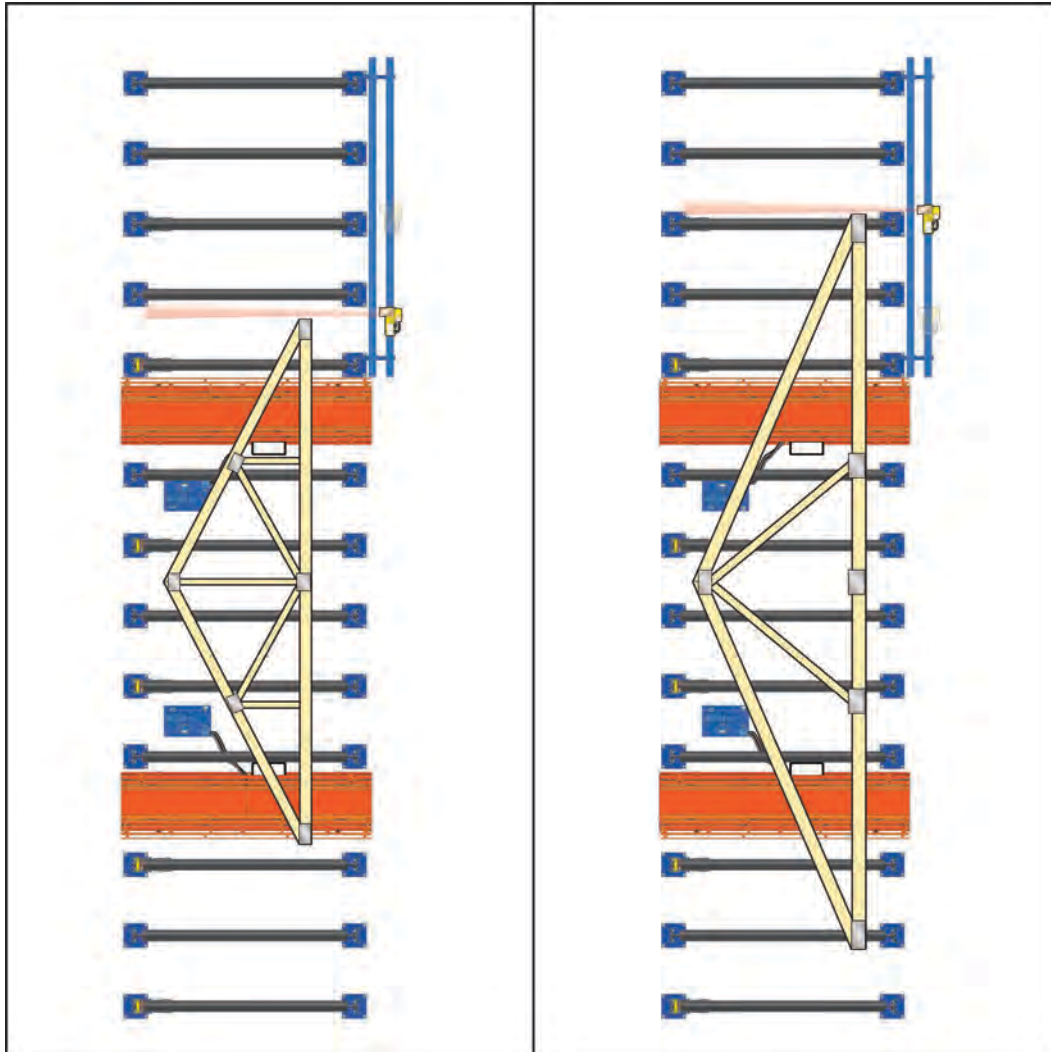

Starting the Horizontal Stacker

Follow this procedure at the start of each day to start the Horizontal Stacker.

	NOTICE
	<p>MiTek recommends leaving the disconnect switch on the heater enclosure in the On position overnight.</p> <p>The heaters prevent the hydraulic fluid from thickening when the ambient temperature drops.</p>

1. Check the hydraulic fluid level of each hydraulic tank by using each tank's sight gauge. See page 51 for more details about checking the hydraulic fluid.

Figure 5-10: Sight Gauge

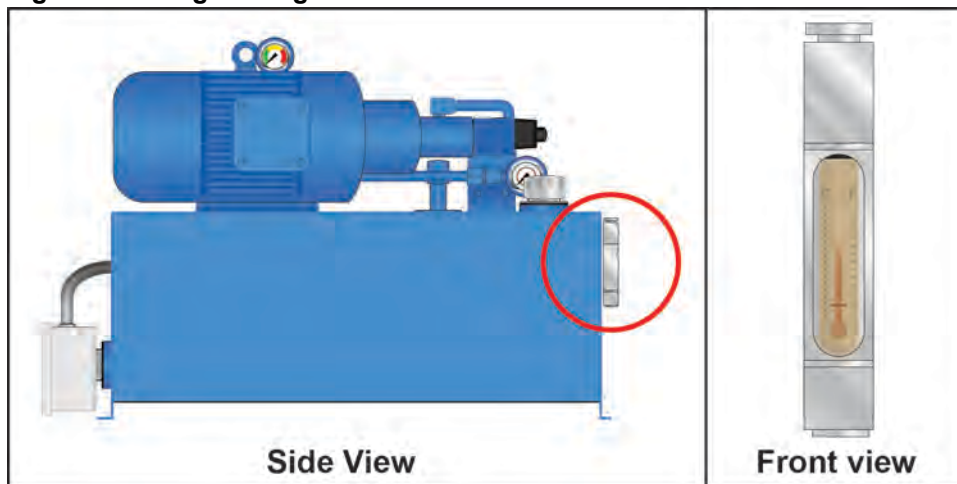

2. Turn the disconnect switches on all of the enclosures to the On position.

Figure 5-11: Disconnect Switches on the Main Electrical Enclosure

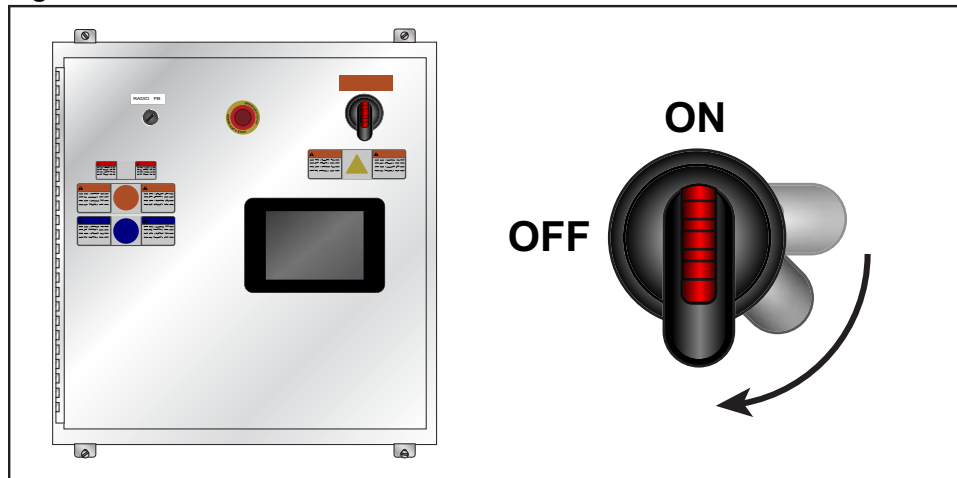

3. Turn any interlocked machines on.
4. Perform the safety test on page xiii.

Operating the Horizontal Stacker in Manual Mode

Follow this procedure for the first truss that you place in each area. Using manual mode before using auto mode allows you to position poles into the receiver stands during stacking. This keeps trusses stacked properly in auto mode.

1. Make sure that the Stand Alone Conveyors are running.
2. Turn the selector switch on the pushbutton enclosure to Manual mode.

Figure 5-12: Switching to Manual Mode

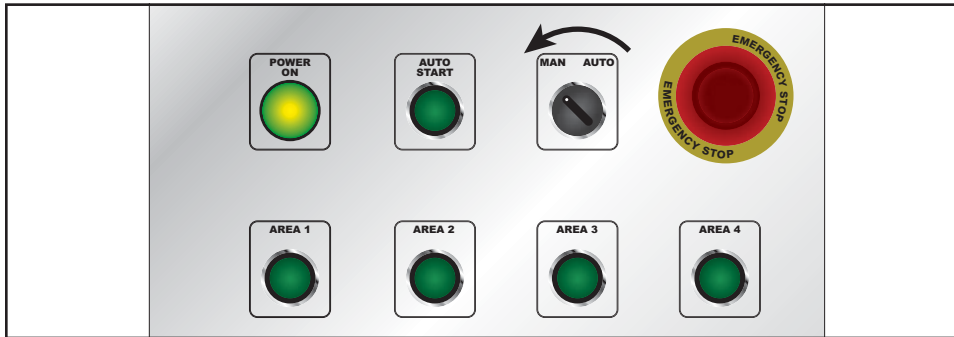

3. Select an area to stack the truss by pressing and holding any of the available Area buttons until the button illuminates.

A four-area system is able to stack a single long truss across two areas at once by pressing and releasing both even or both odd Area buttons at the same time.

Figure 5-13: Selecting an Area

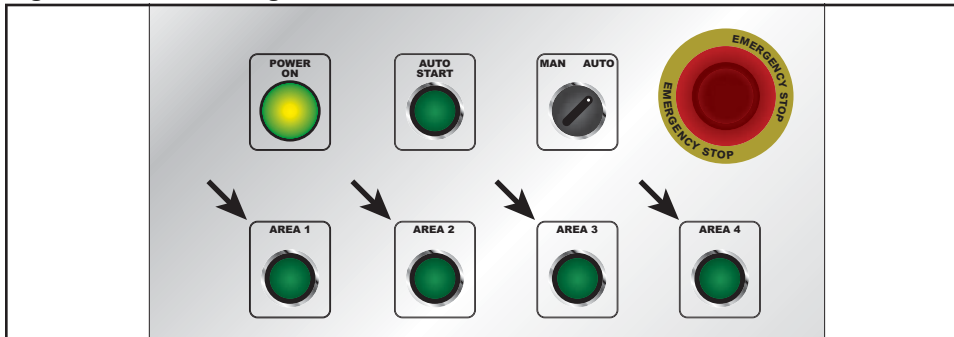

4. When the truss is centered between the correct transporters, press and hold the Raise button until the transporters fully extend upward.

Figure 5-14: Raising Truss

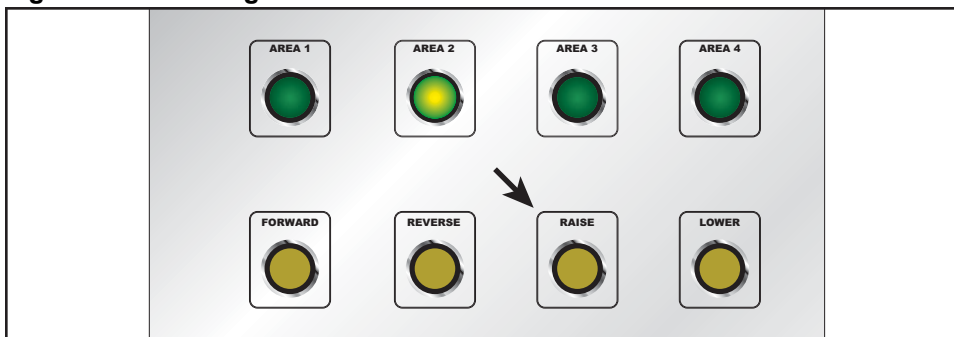

See page 5 for a graphic showing a two-area system.

See page 6 for a graphic showing a four-area system.

5. Move the truss over the correct area.
 - To move the truss into an odd area, press and hold the Forward button until the boom extends completely.
 - To move the truss into an even area, press and hold the Reverse button until the boom extends completely.

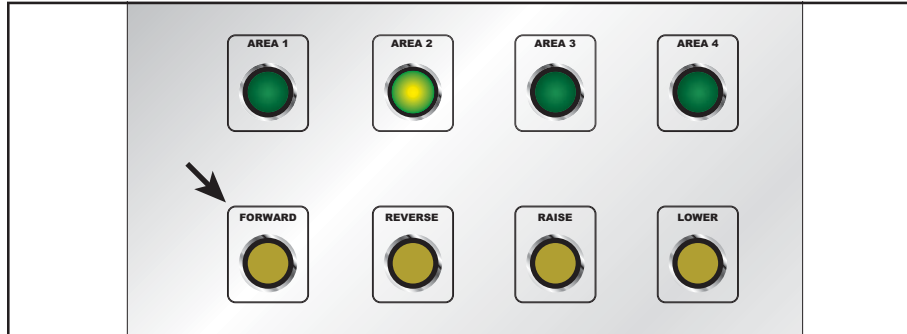
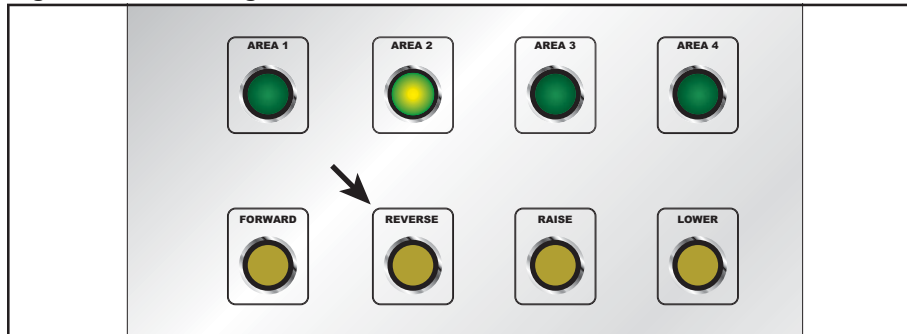
Figure 5-15: Moving Truss to Odd Area**Figure 5-16: Moving Truss to Even Area**

6. Press and hold the Lower button until the truss settles onto the receiver stands.

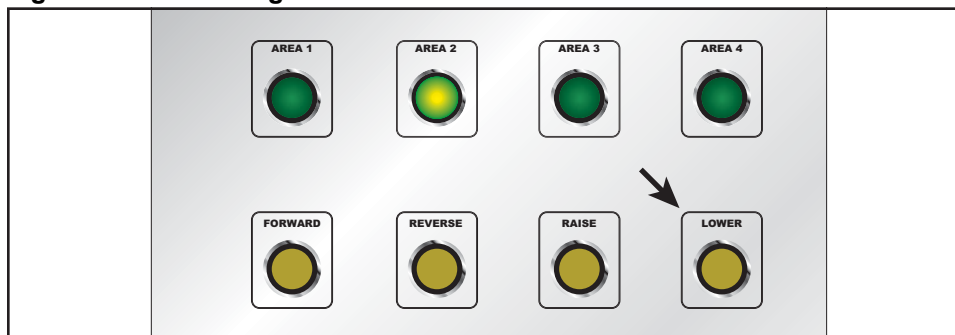
Figure 5-17: Lowering Truss

7. Retract the boom.
 - If you pressed the Forward button in step 5 on page 24, press and hold the Reverse button until the boom finishes retracting.
 - If you pressed the Reverse button in step 5 on page 24, press and hold the Forward button until the boom finishes retracting.

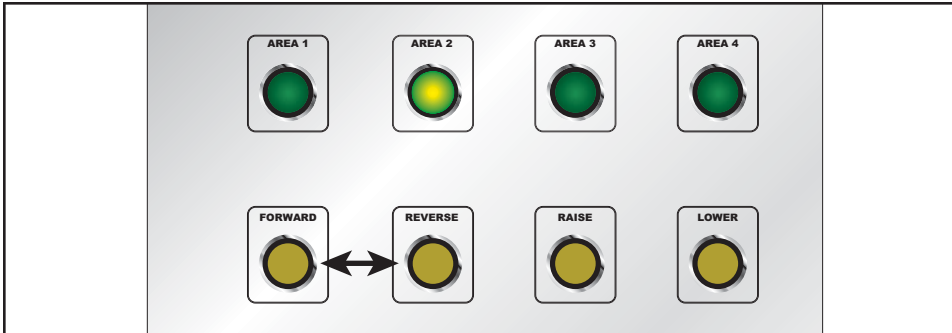

Figure 5-18: Retracting the Boom

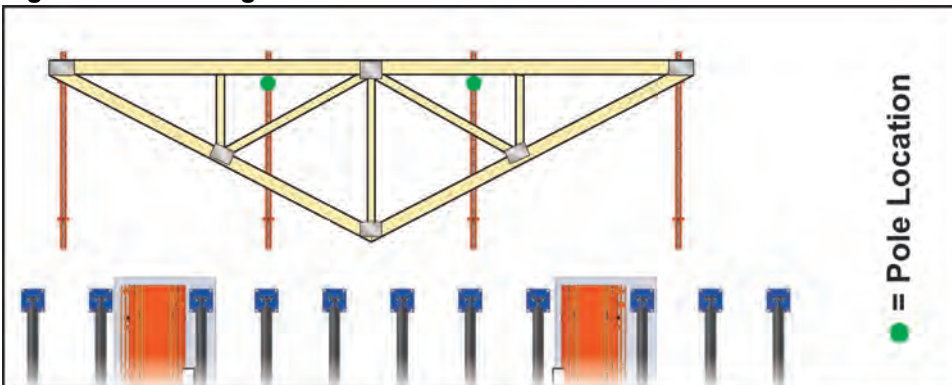
8. Install the poles through the web of the truss into the receiver stands so that the next truss stays in position when the boom retracts.
Make sure the poles are installed symmetrically and installed so that they do not touch connector plates.

Figure 5-19: Placing Poles

Operating the Horizontal Stacker in Auto Mode

Use the scanner positioning procedure on pages 20 through 21 and the manual mode procedure on page 23 to place the first truss into an area before using auto mode. Using manual mode allows you to position poles into the receiver stands during stacking. This keeps trusses stacked properly in auto mode.

	 CAUTION
	<p>Make sure to position each scanner before operating the Horizontal Stacker in Auto mode.</p> <p>Failure to position scanners properly may cause a truss to shift while the transporters raise it, resulting in equipment damage or injury to people near the restricted zone.</p>
	NOTICE
	<p>Make sure to use the manual mode procedure to position the first truss and insert poles into it.</p> <p>Trusses do not stack properly if the poles are not in position before you operate the Horizontal Stacker in auto mode.</p>

1. Turn the selector switch on the pushbutton enclosure to Auto mode.

Figure 5-20: Switching to Auto Mode

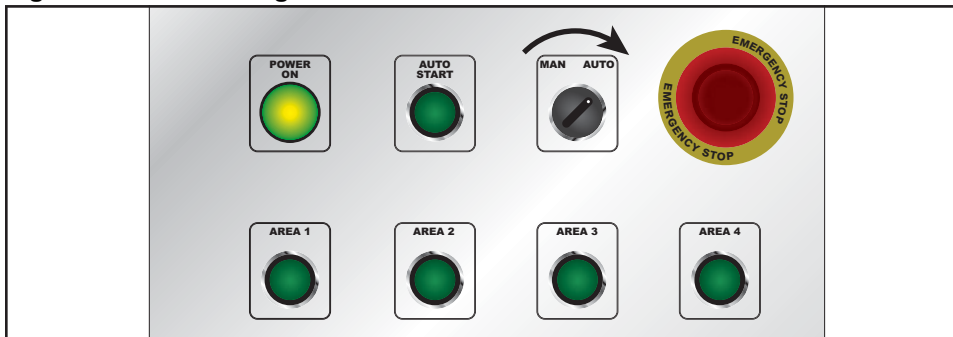

2. As the truss exits the Finish Roller, press and hold the desired Area button until it illuminates to select the area.

Figure 5-21: Selecting an Area

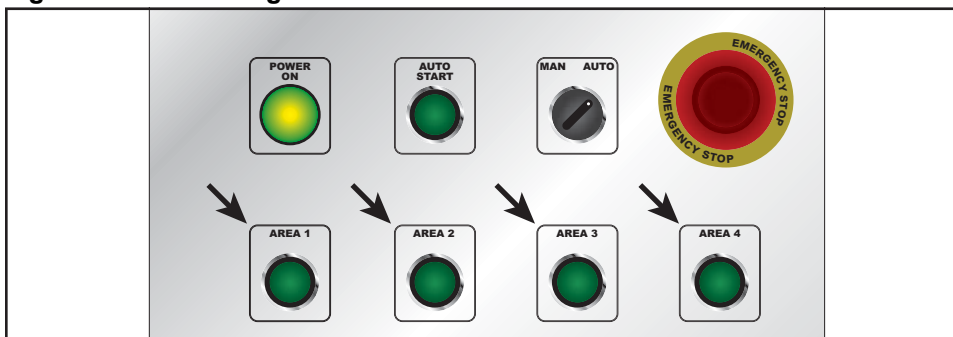

3. Press and hold the Auto Start button until it illuminates.
The transporters for the selected area automatically lift the truss when scanner for that area detects the leading edge of the truss.

Figure 5-22: Starting the Automatic Stacking Sequence

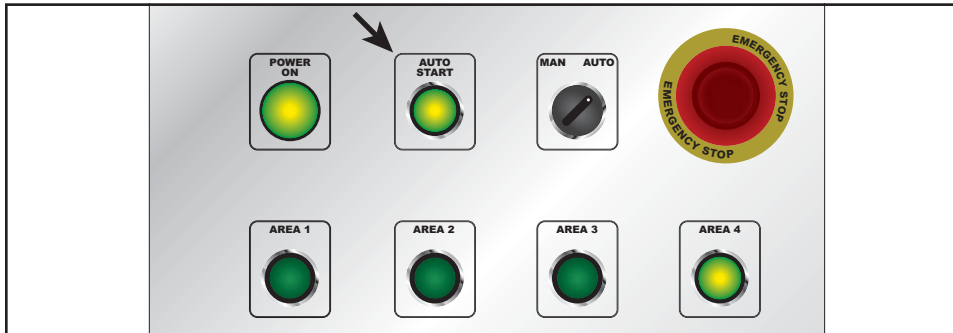

4. Stack the next truss depending on its destination.
 - To stack the next truss in the same area, no further action is needed.
 - To stack the next truss in a different area, repeat steps 2 and 3 and select a different area.

Using the Reset Button

The Reset button on the pushbutton enclosure resets the electrical system so that the Horizontal Stacker can operate again in Auto mode. The Reset button is useful in the following two situations:

- indicator lights start flashing to signal a fault, or
- the transporters start moving out of time with one another.

If one of the two situations above occurs, correct the fault (some faults require a manual reset of an overload or breaker) or use the manual controls to re-time the transporters. Then use the following steps to make the Horizontal Stacker ready to operate again.

1. Turn the selector switch on the pushbutton enclosure to Manual mode.

Figure 5-23: Switching to Manual Mode

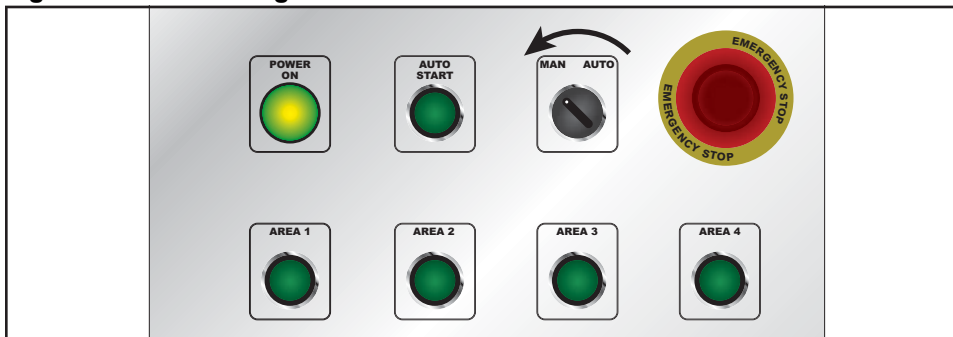

2. Press and release the Reset button.

Figure 5-24: Pressing the Reset Button

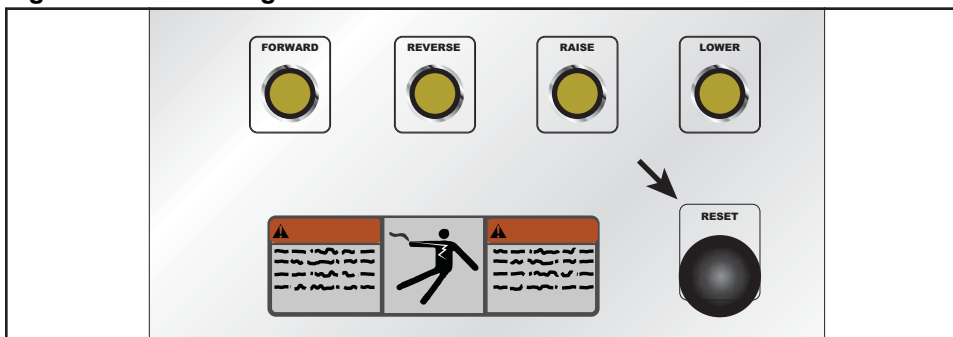

3. Press and hold the Area button until it illuminates to reselect the area.
4. Use the manual controls to return the transporters back to their lowered states with their booms completely retracted. See page 23 for detailed instructions on operating in Manual mode.
5. Operate the system in Auto mode again. See page 26 for detailed instructions on operating the system in Auto mode.



See pages 73 through 76 for more information about identifying faults.

Alternate Operator Controls

Using the Touch Screen

The touch screen on the main electrical enclosure provides most of the same control features as the pushbutton enclosure. Access the controls on the touch screen by pressing **Operator Control Screen** from the main menu.

Figure 5-25: Main Menu



Figure 5-26: Operator Control Menu

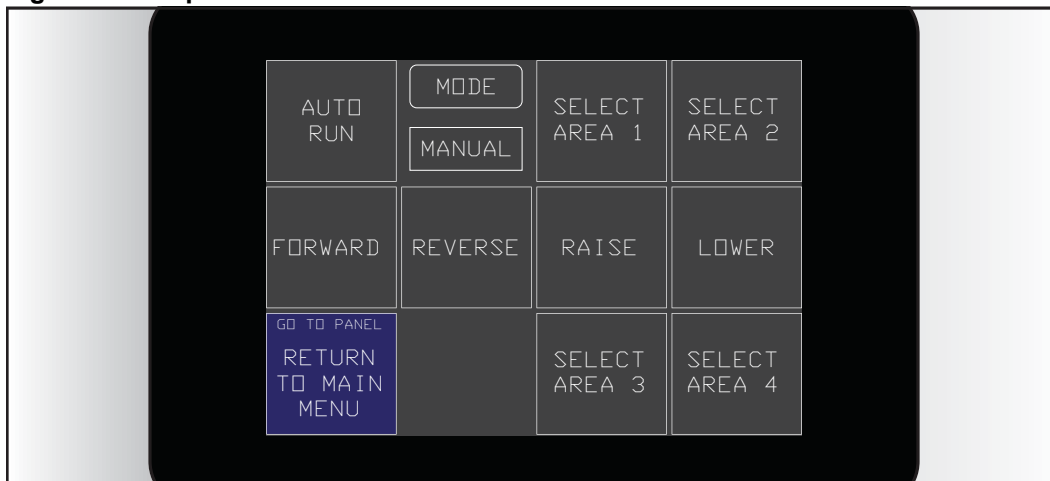

Using the Radio Controller

If your Horizontal Stacker is equipped with a radio controller, you can use the radio controller to operate the transporters. Figure 5-27 explains the functions of the toggle switches on the radio controller.

Use the following steps to operate the radio controller.

1. Press and hold the safety bar.
2. Move the appropriate toggle switch up or down.
3. Release the safety bar and toggle switch.
Both the safety bar and toggle switch return to their neutral positions.

Figure 5-27: Toggle Switches on the Radio Controller

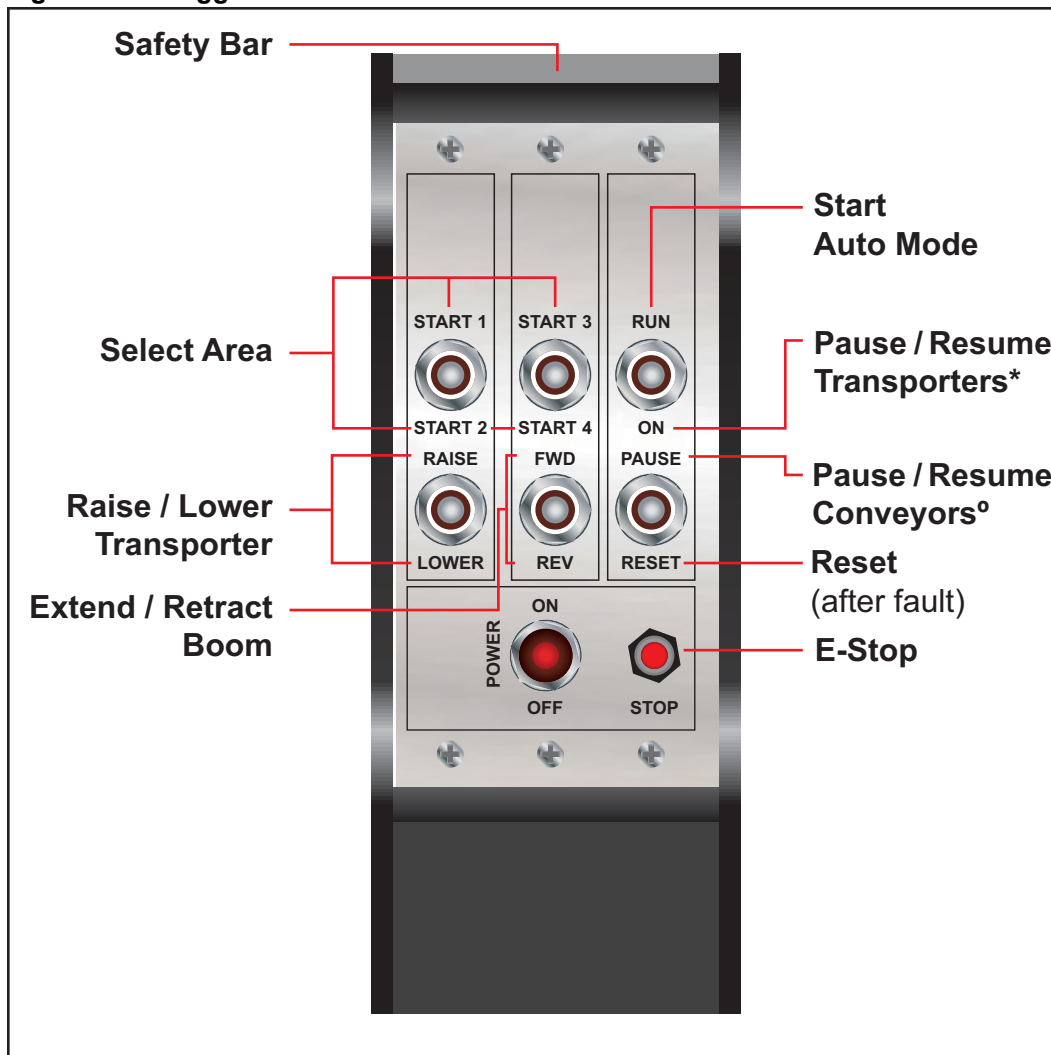

* While in auto mode only

° While in manual or auto mode

Maintenance

Purpose of Chapter This chapter provides step-by-step instructions and other information to help you make repairs and perform preventative maintenance.

Content Overview

- Maintaining Your Machine** 32
- Performing Maintenance Safely** 33
 - Before Operating This Machine 33
 - Lockout/Tagout 34
 - Important Safety Information 34
 - Making Adjustments and Replacing Parts 36
 - Wearing Personal Protective Equipment 37
 - Testing the Safety of the Machine 37
- Selected Component Overviews** 38
 - Electrical Enclosures 38
 - PLC (Programmable Logic Controller) 39
 - HPU (Hydraulic Pressure Unit) 39
- Bracing Transporters** 40
- Unbracing Transporters** 41
- Mechanical System** 42
 - Lubricating Gear Reducers and Chains 42
 - Lubricating Bearings and Pins 43
 - Tensioning Chains 47
 - Adjusting the Electric Motor Brake 49
- Hydraulic System** 50
 - Hydraulic Fluid Recommendations 50
 - Checking Hydraulic Fluid 51
 - Adding Hydraulic Fluid 51
 - Replacing the Filter Element 52
 - Replacing Hydraulic Fluid 53
 - Verifying the Priming of the Pump 55
 - Adjusting Flow Control Valves 56
- Electrical System** 57
 - Setting Tip Switches 57
 - Setting Proximity Switches 59
 - Changing the Rotation of a Motor 59

	NOTICE
	<p>This icon is an important safety note.</p> <p>It indicates that you must lockout/tagout at the appropriate disconnect switch using approved methods described in OSHA CFR 1910.147 before continuing with the procedure.</p>

Maintaining Your Machine

This manual contains sufficient information for proper maintenance under most conditions. Certain environments may require preventative maintenance more frequently.

Review the table of contents and utilize the index to locate the information that you need. The following appendices also assist in maintaining and repairing your machine.

- Troubleshooting
- Parts List
- Maintenance Checklists
- Drawing Set

Because consistent preventative maintenance is so important for keeping your machine in good operating condition, MiTek recommends that you stock certain replacement parts to minimize downtime. See the *Parts List* appendix, starting on page 77.



Read the *Performing Maintenance Safely* section before beginning maintenance on this machine.



Performing Maintenance Safely



Read the safety section starting on page v, and adhere to all rules and guidelines. This section provides additional safety information specific to maintenance topics.

Before Operating This Machine

Review these warnings before operating this machine.

	 WARNING
	<p>ELECTROCUTION, HIGH PRESSURE, AND CRUSH HAZARDS</p> <p>Read this section AND the safety section in the preliminary pages before operating or maintaining this equipment.</p> <p>Do not operate this machine until you have a thorough understanding of all controls, safety devices, E-stops, and operating procedures outlined in this manual.</p> <p>Read and observe all hazard instructions. Failure to do so may result in economic loss, property damage, and/or personal injury.</p> <p>This manual must always be available to personnel operating and maintaining this equipment.</p>



	 WARNING
	<p>CRUSH HAZARD</p> <p>Guards must always be in place during operation to avoid serious injury and possibly death.</p> <p>Always replace guards after completing maintenance and before removing the lockout/tagout device.</p>

	 WARNING
	<p>CRUSH HAZARD.</p> <p>Before turning on the equipment, make sure that all personnel and equipment are clear.</p>

Lockout/Tagout

The lock and tag symbol shown here indicates that proper lockout/tagout procedures must be used prior to starting the procedure where the symbol occurs.



 WARNING	
 	<p>ELECTROCUTION AND HIGH PRESSURE HAZARDS</p> <p>Always turn the power off by activating an E-stop when the equipment is not in operation.</p> <p>Always verify that all power to the machine has been turned off and follow approved lockout/tagout safety procedures (OSHA 29 CFR 1910.147) before performing any maintenance on this equipment.</p> <p>If it is absolutely necessary to troubleshoot an energized machine, follow NFPA 70E or the governing regulations at your location for proper procedures and personal protective equipment.</p> <p>The components on this machine can cause severe injury if adjusted improperly. Follow all procedures in this manual and do not make adjustments to the machine without guidance from MiTek or MiTek documentation.</p> <p>Only trained personnel should make mechanical adjustments to this machine.</p>

Important Safety Information



Your Responsibilities

Detailed descriptions of standard workshop procedures, safety principles, and service operations are not included in this manual. Although this manual contains some warnings and cautions against specific service methods which could cause personal injury or damage to the machine, it does not cover all conceivable ways of service which might be done or the possibility of hazardous consequences of each conceivable way. If you intend to handle, operate, or service the unit by a procedure or method not specifically recommended by the manufacturer, first make sure that such a procedure or method will not render this equipment unsafe or pose a threat to you and others.

It is the responsibility of the mechanic performing the maintenance or service on a particular machine to:

1. Inspect the machine for abnormal wear and damage;
2. Choose a procedure which will not endanger his or her safety, the safety of others, the equipment, or the safe operation of the machine;
3. Fully inspect and test the machine and the hydraulic, mechanical, and electrical systems to ensure that the service to the machine has been properly performed and that the machine, hydraulic, mechanical, and electric systems will function properly; and

4. Ensure only qualified electricians perform electrical service work.

 WARNING	
	This machine uses high-voltage electricity, which may cause serious personal injury or death.

General Service Rules

1. The design may change or upgrades may occur for any particular component. Always contact the factory before replacing components.
2. If inspection or testing reveals evidence of abnormal wear or damage to the machine or if you encounter circumstances not covered in the equipment manual—STOP—and consult MiTek. The machine must be repaired and serviced according to the current specifications and procedures of MiTek, using replacement parts with properties equal to or greater than those specified by MiTek.
3. Use the correct tools and procedures on this machine, to avoid damage and incorrect assembly.

NOTICE	
	Never use compressed air inside an electrical enclosure. It may force contaminants into electrical connections. Use a vacuum to remove dust from electrical enclosures. Canned air is acceptable after vacuuming.



4. Always install new gaskets, O-rings, cotter pins, etc., and place Loctite on bolts, if required.
5. Torque bolts and fasteners to the correct specifications.
6. Clean parts in a nonflammable or high-flash-point solvent only.
7. Lubricate any sliding surfaces before assembly.
8. Many components are manufactured from high carbon, heat-treated steel. Do not attempt to straighten, bend, or weld these components, as they may fail under load causing serious personal injury or death.
9. After re-assembly, check all parts for proper installation and operation before putting the machine back into service.
10. It is beneficial to record all major maintenance and testing. This allows recurring problems to be predicted and addressed before any production time is lost. Typical reports and records should include:
 - Date
 - Serial number of machine

- Description of problems or symptoms
- Corrective action taken
- Parts required

11. MiTek will, from time to time, mail out service bulletins and updates for this machine. Follow the service bulletins and updates accordingly and file them in this equipment manual.

Making Adjustments and Replacing Parts



Be careful when making mechanical adjustments. Untrained personnel may damage the machine or cause harm to themselves and others.

	 WARNING
	<p>CRUSH AND CUT HAZARDS</p> <p>Always replace guards after servicing.</p> <p>Only qualified maintenance personnel shall repair, remove, or replace guards and safety devices.</p>

	NOTICE
	<p>Failure to follow the step-by-step procedures in this chapter may result in incorrect adjustment of this machine.</p> <p>Only trained maintenance personnel should make mechanical adjustments to this machine.</p> <p>Use only the exact replacement parts specified in this manual.</p>

Special materials have been used for some of the components of this equipment. It is critical to the future performance of this machine that only specified replacement parts are used. Order all replacement parts through MiTek. Do not substitute parts without first consulting MiTek to determine if it is safe and effective. No electrical system component, cable, connector, or device should be modified, removed, disconnected, changed without specific approval and guidance from MiTek.

Wearing Personal Protective Equipment

	 CAUTION
	<p>Follow OSHA guidelines to utilize the proper personal protective equipment (PPE) while performing maintenance.</p> <p>The most common include eye protection, hearing protection, dust masks while blowing off sawdust, gloves while working with solvents, and fire retardant clothing when troubleshooting an energized machine.</p>

Testing the Safety of the Machine

The test procedure in the *Safety* section starting on page xiii MUST be performed by qualified personnel after ANY maintenance, adjustment, or modification.

Testing makes sure that the safety system and machine control system work together to stop the machine quickly. The test should be performed before each shift starts to make sure that the safety features remain in working order.

Selected Component Overviews

Electrical Enclosures

Each Horizontal Stacker has multiple electrical enclosures. The number of electrical enclosures varies by system.

Enclosure	Two-Area System	Four-Area System
Main electrical enclosure	1	1
Heater electrical enclosure	1	1
Motor enclosure	1	2
Radio controller enclosure*	Optional	Optional

* Included only if radio controller is included with system

Figure 6-1: Example of Electrical Enclosures

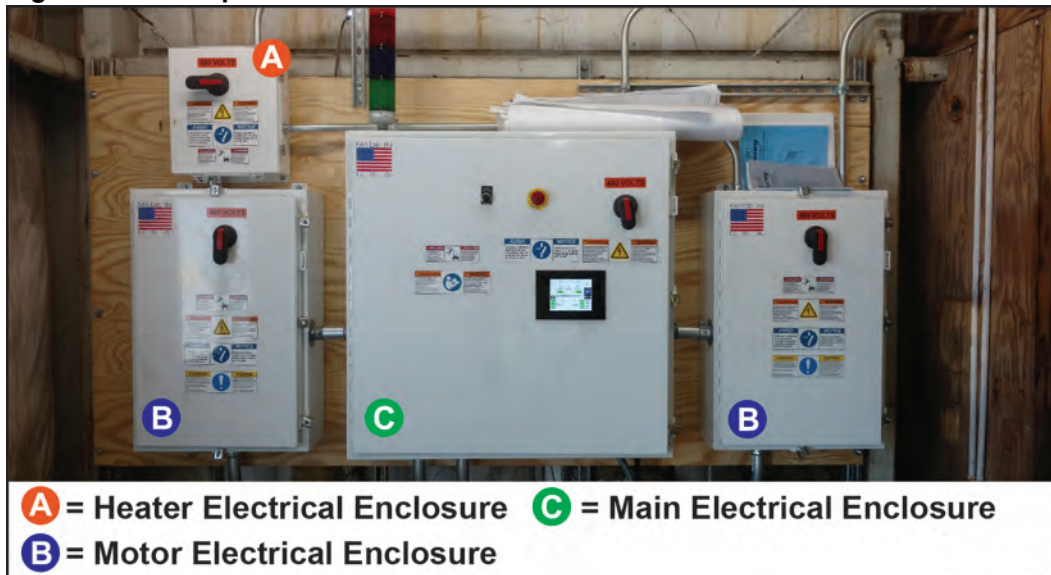

The above graphic shows enclosures for a four-area system.

Figure 6-2: Example of Radio Controller Electrical Enclosure



PLC (Programmable Logic Controller)

The PLC contains the logic that operates the electrical system of the transporters. The PLC operates using input from controls when in Manual mode or using input from sensors in Auto mode. It is located inside the main electrical enclosure. See Figure 6-3.

Figure 6-3: PLC in Main Electrical Enclosure



HPU (Hydraulic Pressure Unit)

An HPU accompanies each transporter. The HPU provides the power to raise a transporter with a truss and then return the transporter to its lowered position. The HPU consists of a tank, motor, pump, filter, valve, and gauges. See Figure 6-4 for an example of an HPU.

Figure 6-4: Hydraulic Pressure Unit

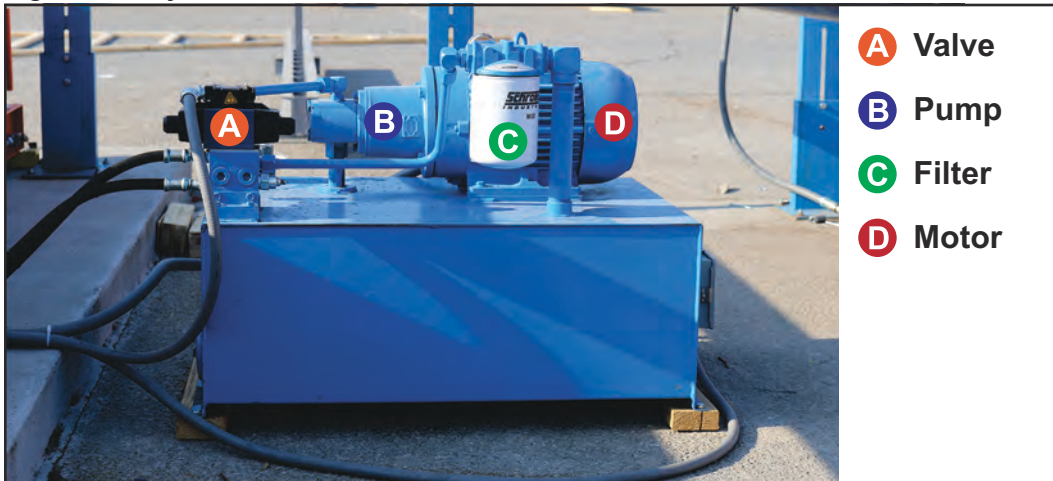

Bracing Transporters.

Brace the transporters to keep the transporters from lowering while performing maintenance on them.

1. Use manual mode to raise the transporter 4' 6" (approximately).
2. Lockout/tagout on the electrical enclosures using steps 1 through 3 on page x.
3. Insert a pair of 2x4 boards into the brace pockets near the corners of the transporter. Brace pockets are circled in blue in Figure 6-5.

Figure 6-5: Transporter Braced with Boards

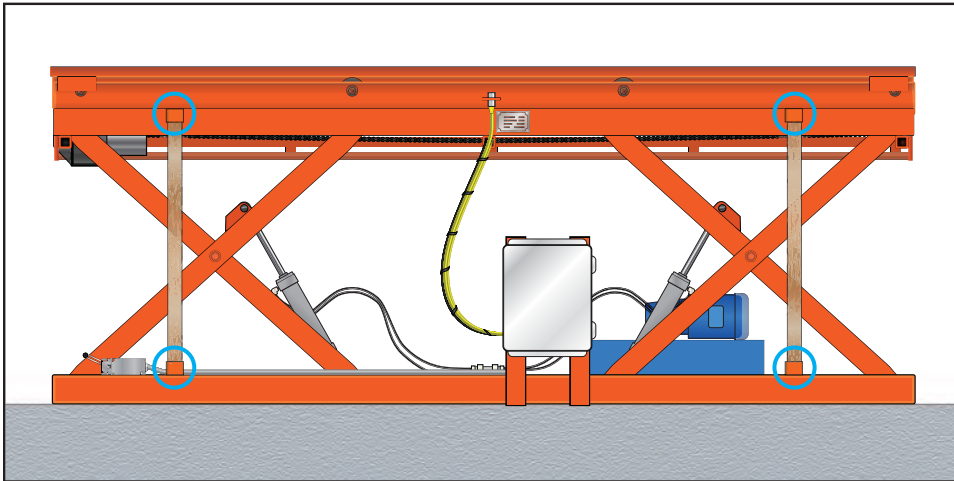

4. Locate the valve on the hydraulic pressure unit. Use the valve's manual override to lower the transporter onto the boards.

Figure 6-6: Manual Override on Valve

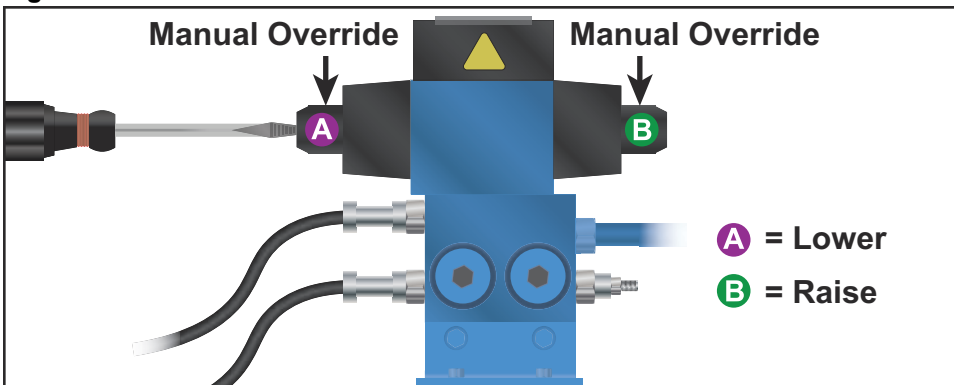

5. Press and hold the other side of the manual override for a few seconds to bleed residual pressure.



2x4 boards
cut to 4'
(eight per
transporter)

Flathead
screwdriver



See page 23 for
instructions on
operating the
transporters in
manual mode.



See Figure 6-21
on page 55 for a
graphic showing
the manual
override on the
valve.

Unbracing Transporters

Use the following steps to unbrace a transporter after you have braced it using the procedure on page 40.

1. Remove the lock and tag from the main electrical enclosure.
2. Use manual mode to raise the transporter enough to remove the boards.
3. Lockout/tagout on the main electrical enclosure.
4. Remove the boards.
5. Remove the lock and tag. Restore power.
6. Return the transporter to its lowered position.

Mechanical System

Lubricating Gear Reducers and Chains

Lubricating Chains

The drive chains on the undersides of the booms should be lightly lubricated once every week. The lubricant should be a high-grade, non-detergent, petroleum-base oil. Anti-foam, anti-rust, and film-strength improving additives are often beneficial. SAE 30 grade is recommended.

Use a clean rag to wipe down the chains. Apply oil to the edges of the link plates of the chain near where the chain makes contact with a sprocket and to the inside of the chain generally.

Lubricating Gear Reducers

The gear reducers connected to the electric motors are sealed by the OEM. Inspect the gear reducers once a week to make sure that no oil is leaking.



Printable
maintenance
checklists start
on page 82.

Lubricating Bearings and Pins

Use a grease that matches the specifications in Table 6-1 to lubricate the bearings. Intervals for lubricating bearings and pins are detailed below.

Table 6-1: Grease for Bearings and Pins

Specification	Technical Data
Type	Lithium
NLGI grade	2

Lubricating Boom Wheel Bearings

Each transporter features twenty crown tread wheels to extend and retract the boom. See Figure 6-7 for an example of a crown tread wheel on the boom.

The bearings of these wheels should be greased every three months (one shift) or every six weeks (two shifts). Use a grease that matches the specifications in Table 6-1.

Figure 6-7: Crown Tread Wheel

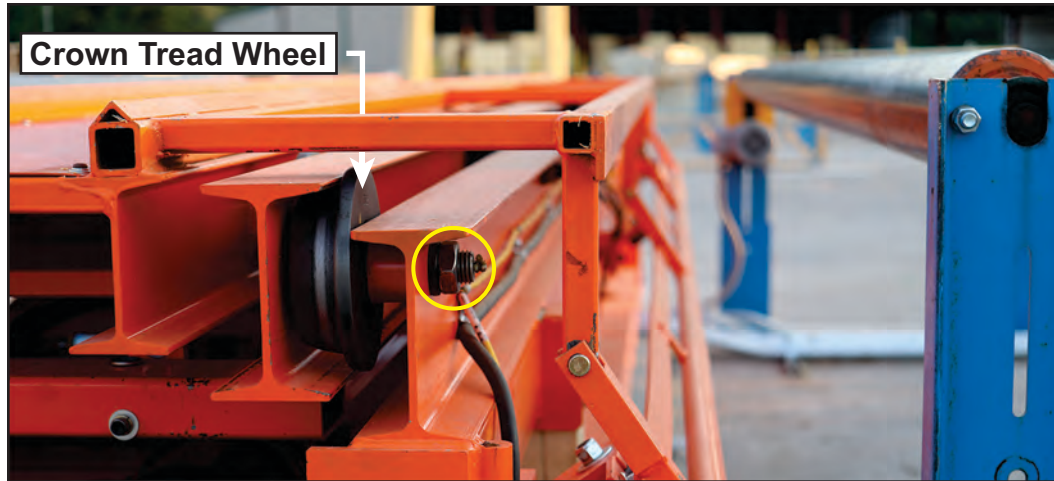

Lubricating Scissor Arm Middle Bearings

Each transporter features bearings in the middle of its scissor arms to allow the transporter to raise and lower the boom. See Figure 6-8 for an example of a middle bearing.

The bearings on middles of the scissor arms should be greased every three months (one shift) or six weeks (two shifts). Use a grease that matches the specifications in Table 6-1 on page 43.

Figure 6-8: Scissor Arm Middle Bearings

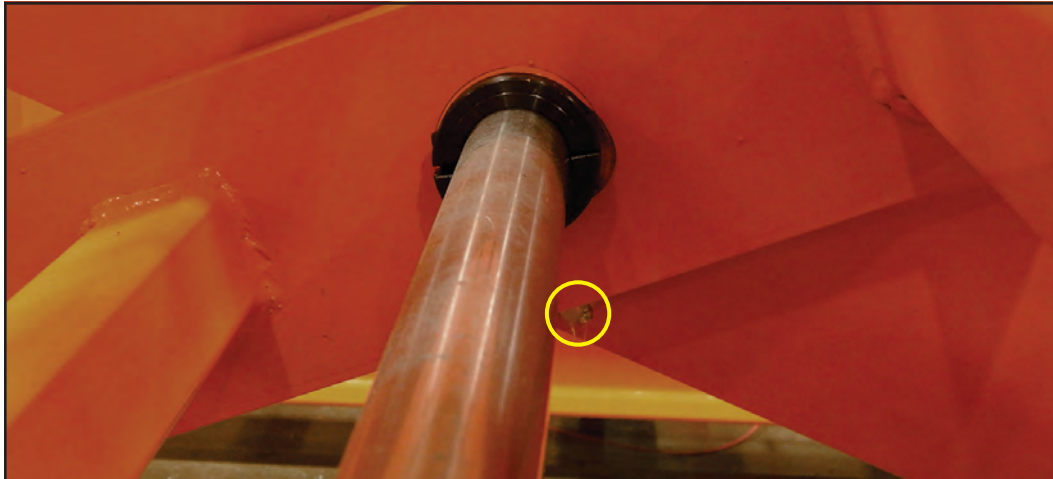

Lubricating Scissor Arm Wheel Bearings

Each transporter features eight wheels on its scissor arms to allow the transporter to raise and lower the boom. See Figure 6-9 for an example of a scissor arm wheel.

The bearings of these wheels should be greased every three months (one shift) or six weeks (two shifts). Use a grease that matches the specifications of Table 6-1 on page 43.

Figure 6-9: Scissor Arm Wheel Bearings

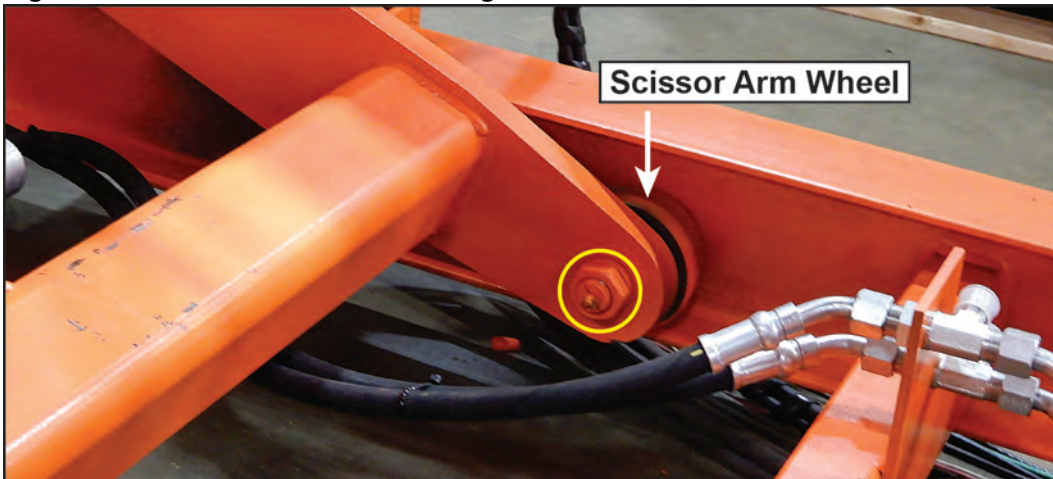

Lubricating Scissor Arm End Bearings

Each transporter features eight bearings that allow the scissor arms to raise and lower the boom. See Figure 6-10 for examples of these bearings.

The bearings on the ends of the scissor arms should be greased every three months (one shift) or six weeks (two shifts). Use a grease that matches the specifications in Table 6-1 on page 43.

Figure 6-10: Scissor Arm End Bearings



Lubricating Hydraulic Cylinder Pins

Each transporter has pins at both the rod and clevis ends of each of its cylinders. See Figure 6-11 for an example of these pins.

The pins should be greased every three months (one shift) or six weeks (two shifts). Use a grease that matches the specifications in Table 6-1 on page 43.

Figure 6-11: Hydraulic Cylinder Pins

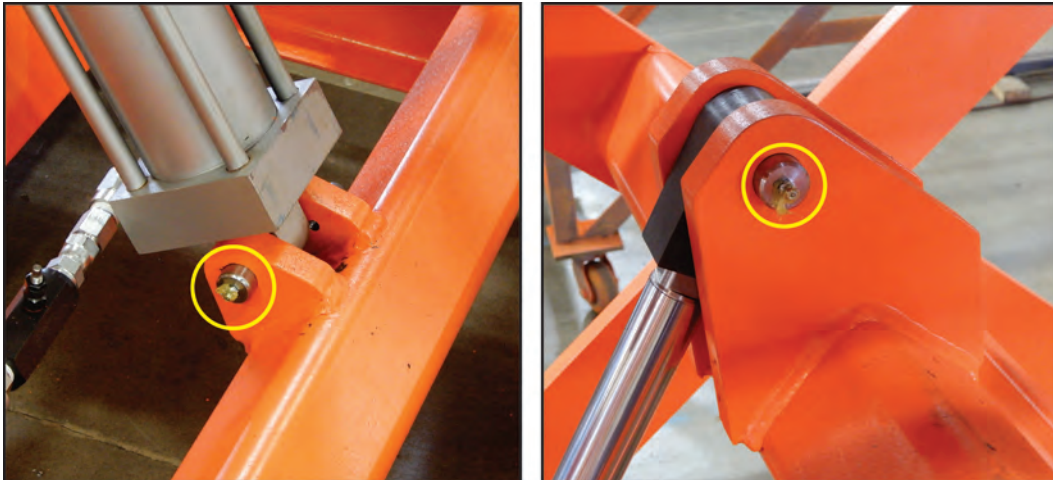

Lubricating Pillow Block Bearings

Each transporter features eight pillow block bearings. See Figure 6-12 for an example of a pillow block bearing.

The pillow block bearings should be greased every six months (one shift) or three months (two shifts). Use a grease that matches the specifications in Table 6-1 on page 43.

Figure 6-12: Pillow Block Bearing

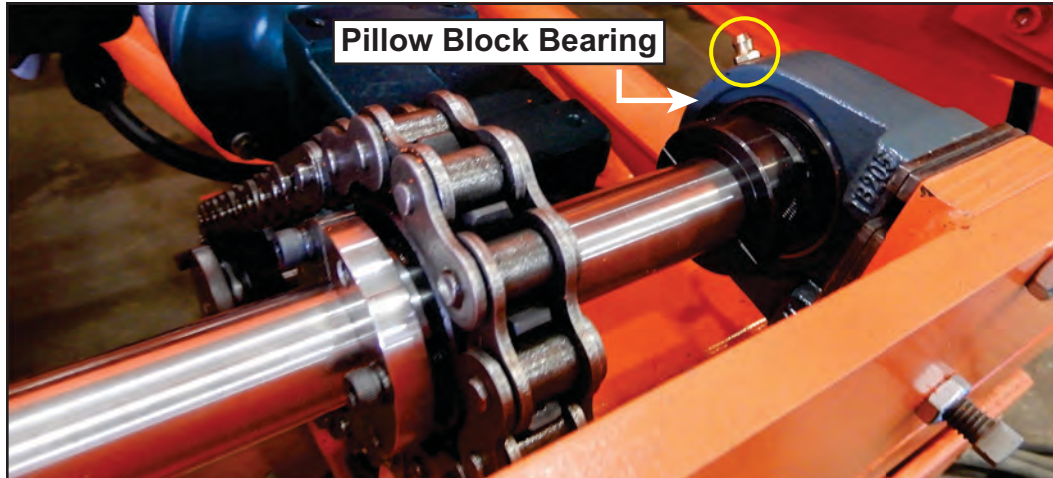

Tensioning Chains

Tensioning No. 40 Chain

The No. 40 chains extend and retract the top part of the boom. These chains should have 1" of sag over their 8' lengths. For major adjustments, add or remove a link. For minor adjustments, use the following steps.

1. Brace and lockout / tagout the transporter using the instructions on page 40.
2. Locate the chain tension rod on the underside of the transporter.

Figure 6-13: Chain Tension Rods

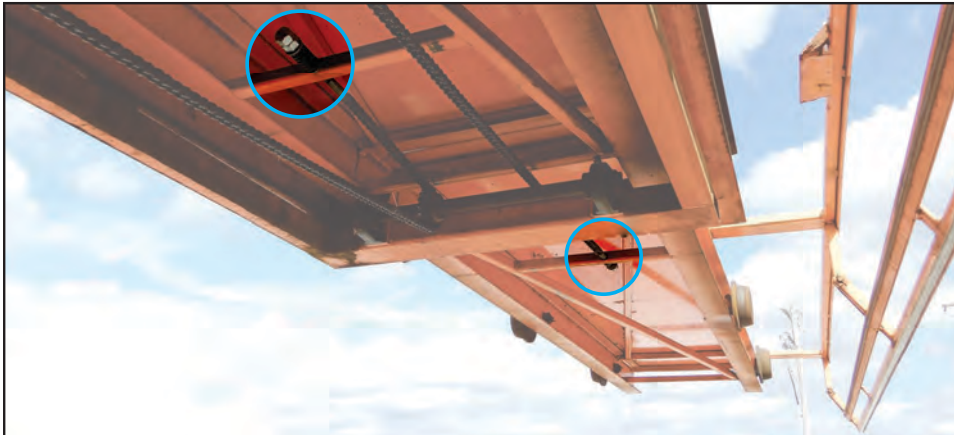

The above graphic shows a boom extended into an odd-numbered area.

3. Turn the jam nut counterclockwise to loosen it.

Figure 6-14: Jam Nut on Chain Tension Rod

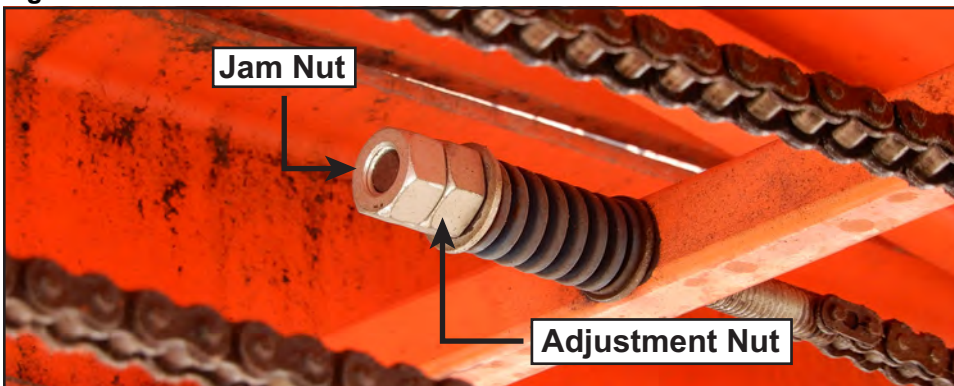

4. Use the adjustment nut to adjust the chain to the correct tension.
 - Turn the adjustment nut clockwise to increase tension.
 - Turn the adjustment nut counterclockwise to decrease tension.
5. Turn the jam nut clockwise to re-tighten it.
6. Remove the lock and tag and unbrace the transporter by using the instructions on page 40.



Adjustable
wrench



Tensioning No. 60 Chain

The No. 60 chains extend and retract the middle part of the boom. They should have 1" of sag over their length. For major adjustments, add/remove a link. For minor adjustments:

1. Brace and lockout / tagout the transporter using the instructions on page 40.
2. Locate the chain tension screws on the end of the boom.

Figure 6-15: Chain Tension Screw Location

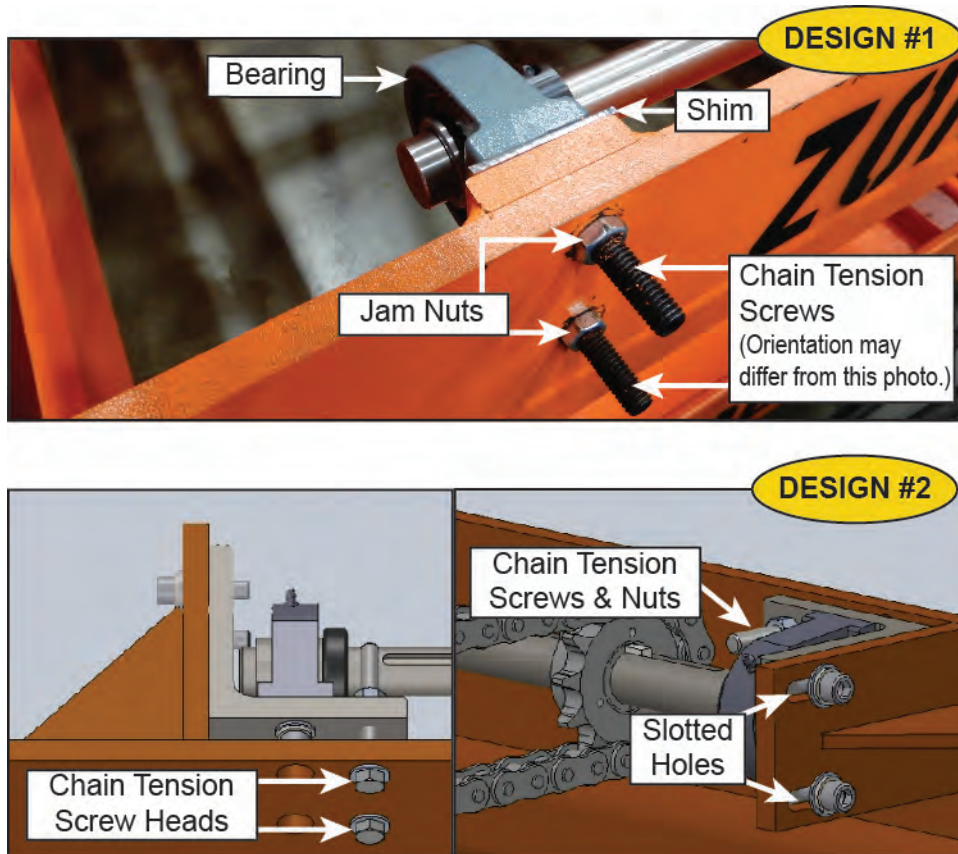

Adjustable wrench



3. Adjust the tensioning screws as indicated here:

DESIGN #1	DESIGN #2
<ol style="list-style-type: none"> a) Turn the chain tension screws and/or their jam nuts to loosen them. b) Add or remove the shims between the pillow block bearings and the frame to adjust tension. <ul style="list-style-type: none"> •To increase tension, remove a shim or shims. •To decrease tension, add a shim or shims. c) You may need to move the motor in the slotted holes while adjusting the chain from that end. d) Re-tighten the chain tension screws and jam nuts. 	<ol style="list-style-type: none"> a) Loosen the screws in the slotted holes. b) Tighten or loosen the chain tension screws and nuts to move the shaft in the correct direction for tightening or loosening the chain. c) Re-tighten the screws in the slotted holes.

4. Remove the lock and tag and unbrace the transporter as described on page 40.

Adjusting the Electric Motor Brake

Adjusting the Air Gap on the Electric Motor Brake

As the brake wears, the air gap increases. A label in front of the plunger shows the point at which the air gap needs to be reset. Adjust the air gap when the extruded part of the plunger reaches the reset height on the label.

Turn the adjusting screws clockwise until the extrusion on the plunger reaches the set height on the label. The adjusting screws are circled in blue in Figure 6-16.



Standard hex key set

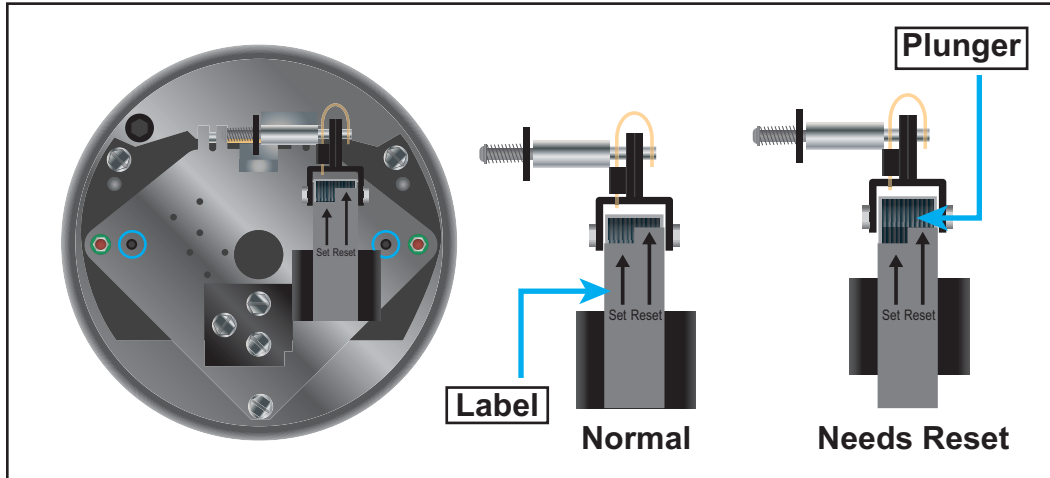

Figure 6-16: Setting the Air Gap



Replacing a Brake Pad on the Electric Motor Brake

Search the Stearns resource library for installation and service instructions for 1-056-X00 series manual adjust brakes. The OEM documentation describes the process of replacing a brake pad in detail.

Hydraulic System

	 WARNING
	<p>HIGH PRESSURE HAZARD.</p> <p>Bleed all pressure from hydraulic lines before performing maintenance on hydraulic components.</p> <p>Residual pressure may cause parts to move suddenly, causing serious injury or death.</p>



See page 40 for a procedure to brace a transporter and bleed lines.

Hydraulic Fluid Recommendations

See Table 6-2 for hydraulic fluid specifications. Selecting hydraulic fluid with the proper viscosity rating is important for the proper functioning of the hydraulic system.

Table 6-2: Hydraulic Fluid Specifications

Attribute	Specification
Recommended operating viscosity range	98-463 SUS
Temperature (at startup)	> 68°F (20°C)
Temperature (during operation)	80 – 120°F (26 – 48°C)
ISO weight	68
Reservoir capacity	40 gallons
Capacity of hydraulic lines, valves, and filters	< 5 gallons

Checking Hydraulic Fluid

Check the level and condition of the hydraulic fluid in the reservoir every by viewing the sight gauge.

- If the hydraulic fluid is below the black line at the top of the sight gauge, add more fluid to the tank.
- If the hydraulic fluid appears white or black, send the fluid to a lab for testing. White or black fluid often indicates dirty fluid and requires changing.



Figure 6-17: Hydraulic Fluid Thermometer and Sight Gauge

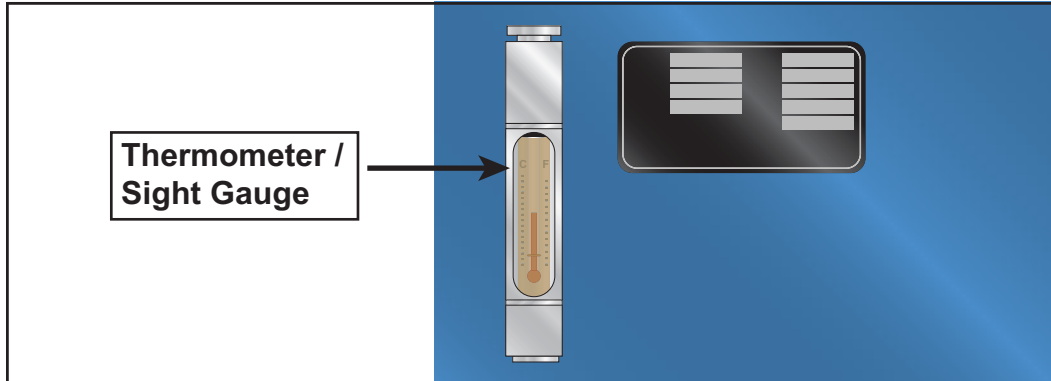

Adding Hydraulic Fluid

1. Make sure all transporters are fully lowered.
2. Unscrew the tank cap and remove the collar and screen underneath it.
3. Fill the tank using a pump equipped with a filter until the fluid in the tank is within 2" of the top of the tank.



- Phillips screwdriver
- Pump with filter
- Hydraulic fluid

Figure 6-18: Hydraulic Tank Cap, Collar, and Screen

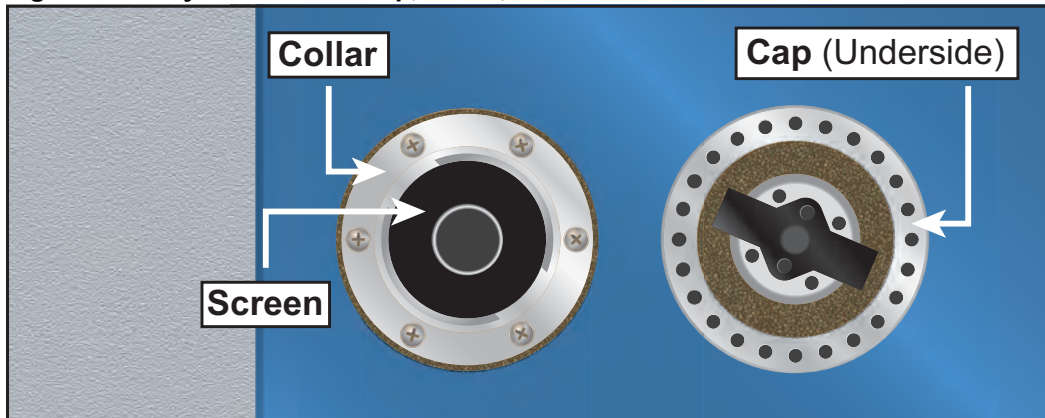

Replacing the Filter Element

Under normal operation, replace the filter element under any one of the following circumstances.

- Replace the filter element as part of routinely scheduled maintenance every twelve months (one shift) or six months (two shifts).
- Replace the filter element immediately if the needle of the pressure gauge rests on yellow or red. The needle on yellow or red indicates a clogged filter element. Send a sample of the fluid for testing when replacing the filter element.
- Replace the filter element one week after replacing hydraulic fluid. New hydraulic fluid has contaminants that the filter element removes in the first week of operation.

Figure 6-19 shows the filter element.

Figure 6-19: Hydraulic Fluid Filter

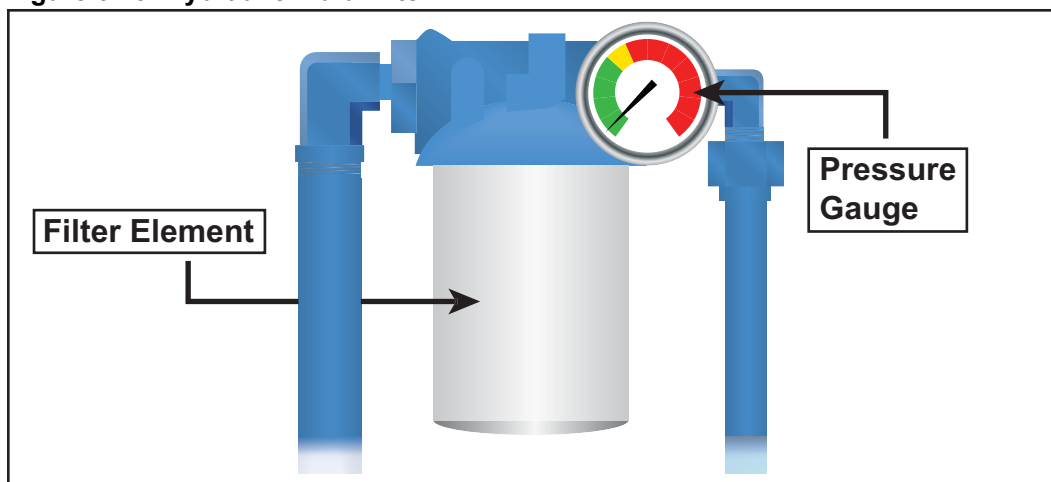

1. Make sure all transporters are fully lowered.
2. Lockout / tagout on the main electrical enclosure.
3. Place a pan underneath the filter element to catch any residual hydraulic fluid.
4. Clean the exterior of the filter element with a soft cloth.
5. Unscrew the filter element by turning it counterclockwise. Do not tilt the filter element while unscrewing and removing it to prevent spills.
6. Lightly lubricate the seal ring of the new filter with hydraulic fluid.
7. Install the new filter element by turning it clockwise.
8. Remove the lock and tag. Resume operation.

Replacing Hydraulic Fluid

The interval between hydraulic fluid changes depends on the type of fluid used and the environment where the Horizontal Stacker operates.

MiTek recommends sending a sample of hydraulic fluid for testing every time that the filter element is replaced. If the test determines that the fluid is contaminated, replace the fluid immediately.

Otherwise, the hydraulic fluid needs complete draining and replacement every five years (one shift) or two and a half years (two shifts). Always use the hydraulic fluid specified in Table 6-2 on page 50.

Tips for Replacing Hydraulic Fluid

- Drain and change hydraulic fluid when the system is at operating temperature. Draining fluid at operating temperature removes as much of the impurities in suspension as possible.
- Use a suction pump to remove fluid from the reservoir to eliminate the possibility of spills. Some hydraulic fluid suppliers offer this service.
- Always replace the filter element when changing fluid. Replace the filter one week after returning to normal operation as well.
- Drain the reservoir completely when changing the fluid.

Use the following procedure to replace hydraulic fluid.

1. Make sure all transporters are fully lowered.
2. Lockout / tagout on the main electrical enclosure.
3. Remove the cap, cap collar, and screen from the hydraulic tank. See Figure 6-20.

Figure 6-20: Hydraulic Tank Cap, Cap Collar, and Screen

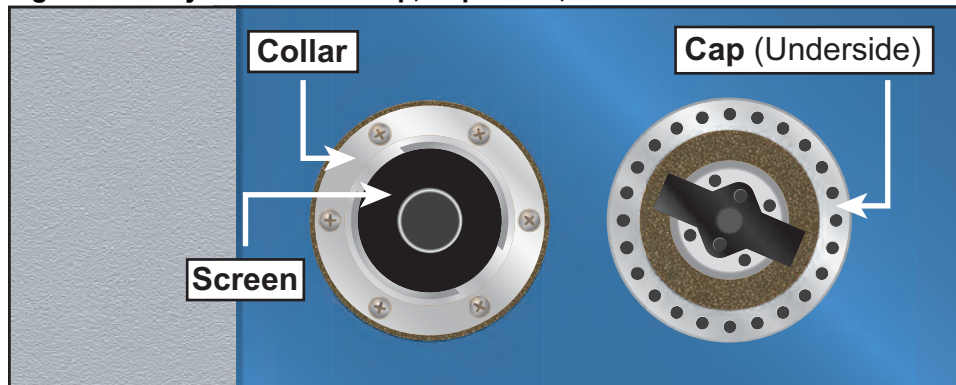

Phillips
screwdriver
Pump with filter
Hydraulic fluid



4. Use a pump to remove the old hydraulic fluid.



	ENVIRONMENTAL
	<p>Do NOT dispose of hydraulic fluid in the municipal waste stream.</p> <p>A waste services provider can remove or recycle hydraulic fluid.</p> <p>Always dispose of hydraulic fluid in accordance with local, state, and federal laws.</p>

5. Pump the new hydraulic fluid into the tank until it reaches 2" below the top of the tank.
6. Replace the cap, cap collar, and screen on the hydraulic tank.
7. Remove the lock and tag from the main electrical enclosure.
8. Verify that the pump is primed according to the procedure that starts on page 55.
9. Resume operation.

	NOTICE
	<p>Replace the filter element one week after replacing hydraulic fluid.</p> <p>New hydraulic fluid has contaminants that the filter element removes in the first week of operation.</p> <p>Failure to replace the filter element a week after replacing the hydraulic fluid causes premature wear on the hydraulic system.</p>

Verifying the Priming of the Pump

Verify the pump priming when starting the Horizontal Stacker for the first time and after refilling the tank.

	 WARNING
	<p>Maintenance personnel must enter the restricted zone while the Horizontal Stacker has electric and hydraulic power.</p> <p>Do NOT come into contact with the transporter during any portion of this procedure.</p> <p>Coming into contact with the transporter while it is moving may result in severe physical injury.</p>

1. Verify that the transporter does not have a load.
2. Follow the directions in steps 2 and 3 on page 2 so that the hydraulic pump runs.
3. Use a screwdriver to press and hold the manual override on the valve as shown in Figure 6-21 until the transporter rises completely.

Figure 6-21: Manual Override on Valve

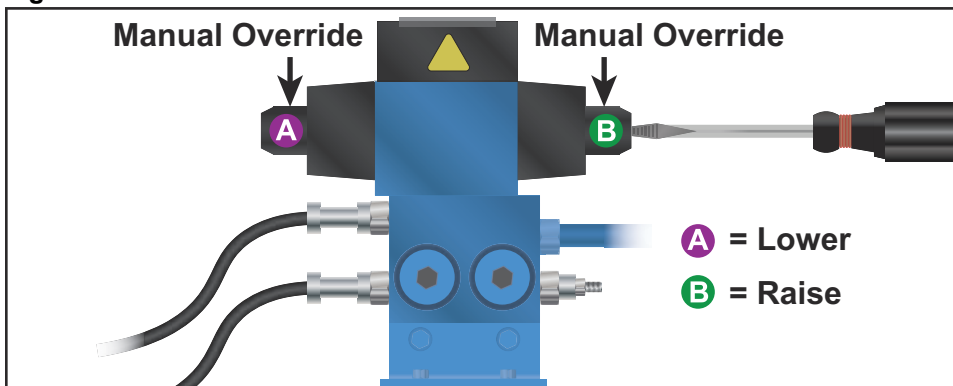

4. Use a screwdriver to press and hold the other side of the manual override until the transporter lowers completely.
5. Proceed based on the operation of the transporter.
 - If the transporter rises and lowers smoothly, the hydraulic system is primed. Proceed to step 6.
 - If the transporter jerks while moving, repeat steps 3 and 4 until the transporter rises and lowers smoothly. Then proceed to step 6.
6. Resume operation.

Adjusting Flow Control Valves

The hydraulic cylinders on the transporters have adjustable flow control valves that control the speed of the transporters as they lower.

The flow control valves are located near the cap ends of the hydraulic cylinders.

The flow control valves are set at the factory before shipping to lower the transporters in seven seconds. The flow control valves do not require adjustment during normal operating conditions.

If the flow control valves do require adjustment at some point, use the following to adjust them:

- Turn the knob on the valve clockwise to reduce flow and slow the transporter as it lowers.
- Turn the knob on the valve counterclockwise to increase flow and speed the transporter as it lowers.

Figure 6-22: Flow Control Valve

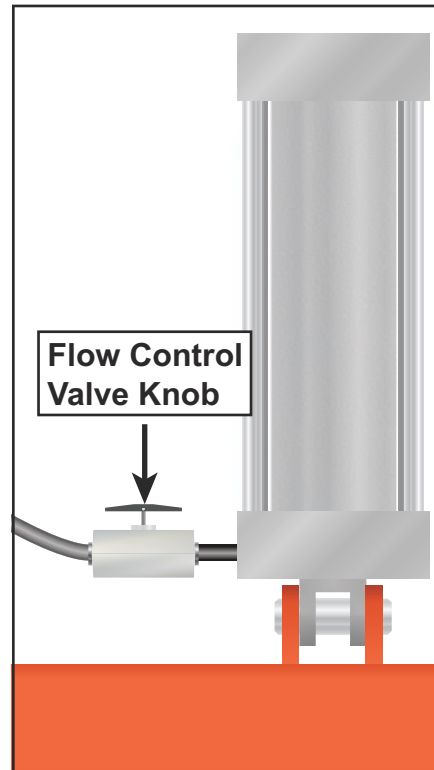

Electrical System

Setting Tip Switches

Tip switches trigger an E-stop when they detect that the transporters are tipping because a truss is too large. The tip switches are set by MiTek technicians in the field and do not need adjustment.

If you replace a tip switch, however, set the adjustable roller arm on the new tip switch after you have placed the new tip switch body onto the transporter frame.

1. Verify lockout/tagout on the main electrical enclosure.
2. Locate the split clamp set screw on the adjustable roller arm.

Figure 6-23: Adjustable Roller Arm Parts

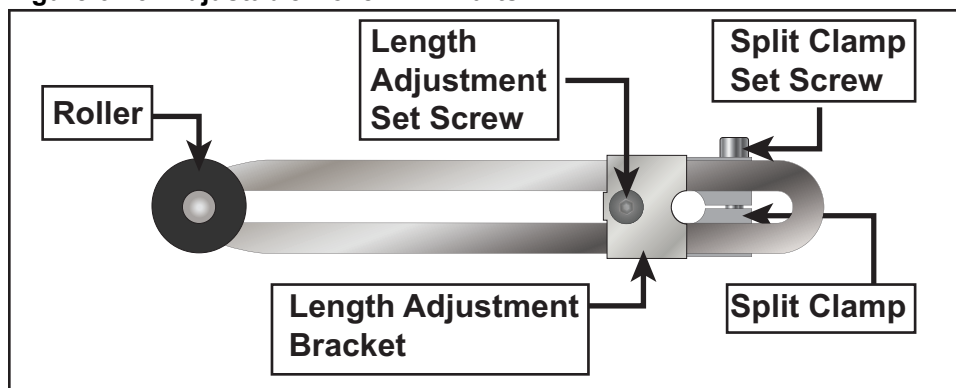

3. Orient the adjustable roller arm so that the roller faces out and away from the frame. See Figure 6-24 for reference.
 - If the split clamp set screw faces up, skip to step 5 on page 58.
 - If the split clamp set screw faces down, continue to step 4.

Figure 6-24: Adjustable Roller Arm Orientation

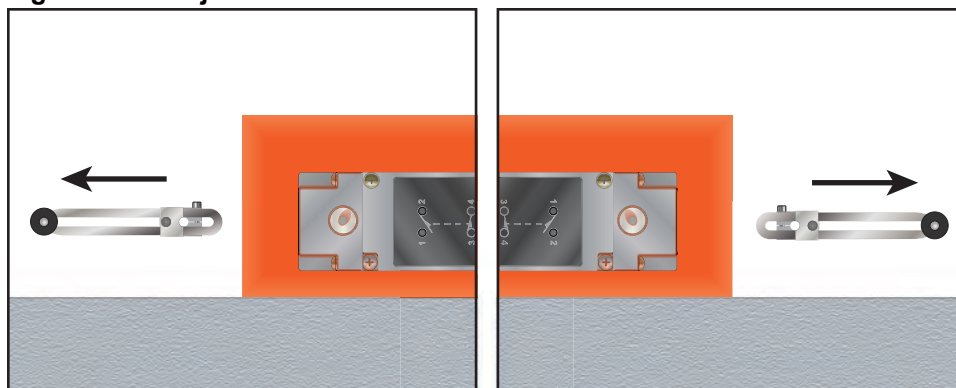

Slotted
screwdriver

Standard hex
key set



4. If the split clamp set screw faces down after the arm is oriented properly, change the orientation of the set screw using the following steps.
 - a) Remove the length adjustment set screw and its washer.
 - b) Remove the length adjustment bracket.
 - c) Flip the split clamp so that the split clamp set screw faces up.
 - d) Reinstall the length adjustment bracket using the length adjustment screw and its washer.
5. Slide the split clamp over the shaft of the tip switch so that the roller rests on the ground away from the frame. See Figure 6-25.

Figure 6-25: Roller Positioning

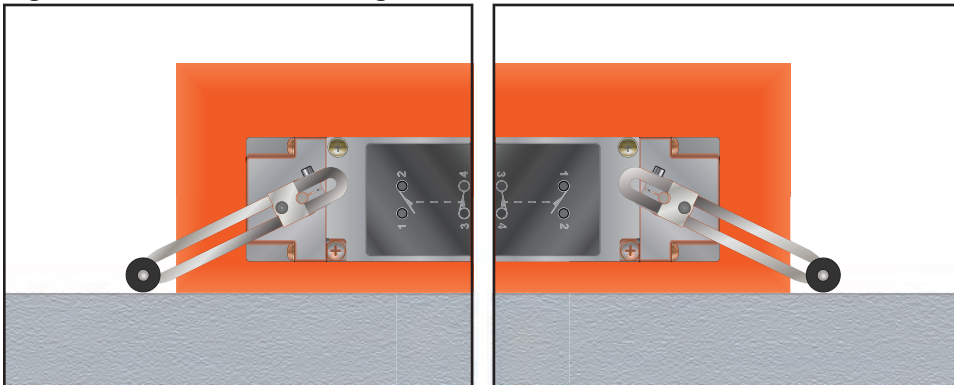

6. Use a slotted screwdriver to turn the shaft 30° as indicated in Figure 6-26 and hold it at that position while you use a hex key to tighten the split clamp set screw.

Figure 6-26: Turning the Tip Switch Shaft

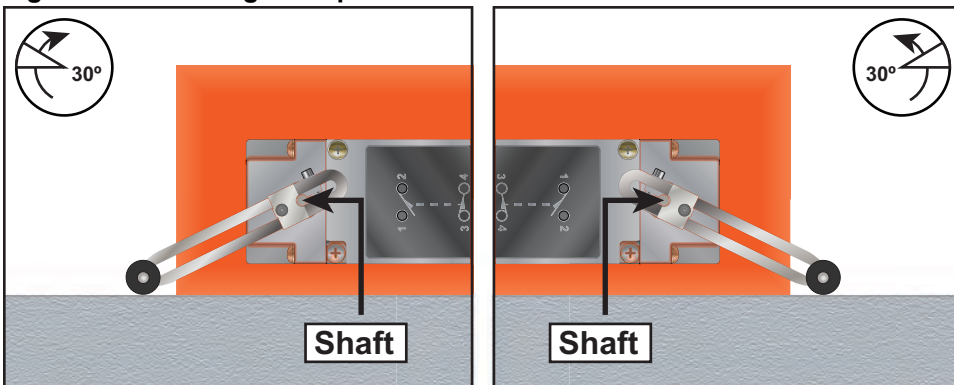

7. Rotate the adjustable roller arm slightly and verify that the shaft on the tip switch rotates. If the shaft does not rotate, repeat step 6 and make sure to tighten the split clamp set screw.
8. Remove the lock and tag. Restore power.
9. Resume operation.

Setting Proximity Switches

Proximity switches detect when a bracket or other part of the frame is close so that the PLC knows when to stop moving the transporter. They are set at the factory and do not need adjustment.

If you replace a proximity switch, make sure the correct metal bracket or swing arm is over the proximity switch. Adjust the switch so that the light on the switch turns green. See Figure 6-27.

Figure 6-27: Proximity Switch

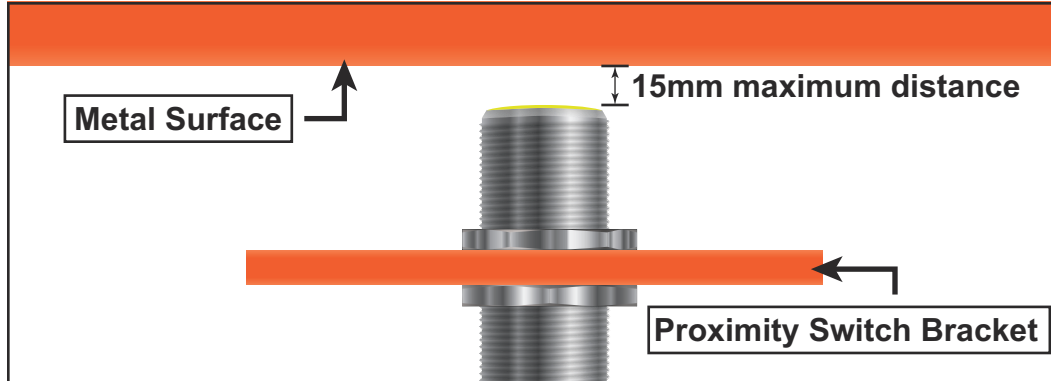

Changing the Rotation of a Motor

All motors on the Horizontal Stacker are 3-phase motors. If the motor is rotating in the wrong direction, lockout/tagout the machine name and swap any 2 of the 3-phase wires.





Troubleshooting

Purpose of Appendix This appendix describes possible problems that you may encounter while operating the machine and suggests solutions for them.

Safety Notes for Troubleshooting

General Troubleshooting Safety Tips

	 WARNING
	<p>ELECTROCUTION, HIGH PRESSURE, AND CRUSH HAZARDS.</p> <p>Read all notes in this section AND the safety section in the preliminary pages before operating or maintaining this equipment.</p> <p>Most solutions are described in more detail in the <i>Maintenance</i> chapter, where there may be additional safety notes.</p>

- Read all warnings located in the safety section in the preliminary pages and adhere to them at all times.
- When the blue lock shown in the margin appears, lockout/tagout at the appropriate disconnect switch using approved methods described in OSHA 29 CFR 1910.147 before continuing with the procedure or troubleshooting.
- If the lockout/tagout graphic does not appear, it is recommended that you still de-energize the machine unless energy is required for the troubleshooting process. If it is absolutely necessary to troubleshoot an energized machine, follow NFPA 70E for proper procedures and personal protective equipment.
- All electrical work must be performed by a licensed electrician.
- Read this manual for information and procedures related to the specific maintenance or troubleshooting issue before attempting any maintenance.
- Safety goggles and a dust mask must be worn for all cleaning steps outlined in this manual. When using cleaning and lubrication solutions, a respirator rated for use with those solutions must be worn, as well as gloves resistant to the solution.



If you have reviewed the *Maintenance* and *Troubleshooting* chapters but have not solved your problem, please call MiTek Machinery Division Customer Service at **800-523-3380** Monday through Friday.



Electrical Troubleshooting Safety Tips

- Make sure that you have the proper tools for the job. See page 62 for more information.
- Make sure that the person performing the troubleshooting is qualified from an electrical knowledge standpoint. If you feel uncertain about troubleshooting electrical power, remember that the cost of an injury far outweighs the cost of hiring an electrician.
- Remove rings or watches. They are extremely conductive material and may catch on small components.
- Get a helper. You are most likely going to need an extra hand at some point, and you shouldn't perform electrical work without someone close by to help if you get injured.
- Be patient. Take your time and stay alert. Never take shortcuts or become too confident in what you are doing.
- Take notes recording what you have checked and what the readings were. This is a good way to check your work when you are finished. Sometimes, the machine won't work because a wire was removed for testing and overlooked when cleaning up. Having notes makes the process go much more smoothly.
- ALWAYS turn the power off if you are checking for ohms or swapping PLC cards.
- ALWAYS push an E-stop button before approaching a machine for any reason. If you are working on encoders, pushing an E-stop is especially important. An interruption to a powered encoder may cause components to move without warning.
- Wear appropriate PPE (personal protective equipment) for working with live power.

Getting Started with Troubleshooting

Tools Required

Before beginning the troubleshooting process or calling MiTek Machinery Division Customer Service, gather the following tools:

- Insulated slotted screwdriver
- Insulated Phillips screwdriver
- Equipment manual and drawings, including any electrical schematics
- Pen and notepad
- UL-listed multimeter

A multimeter is an electronic measuring instrument. The analog versions were referred to as a volt-ohm-meter (VOM). Digital models are referred to as digital multimeters (DMM). Your multimeter should have the following features:

- Voltage (volts) measurement rated above the maximum possible voltage
- Resistance (ohms) measurement
- Current (amps) measurement
- Ability to measure both AC and DC power
- Autoranging feature
- PPE as required by NFPA 70e

First Steps

Mechanical Troubleshooting

Always clean and lubricate the equipment as a first step in most troubleshooting processes. Most mechanical malfunctions are caused by inadequate preventative maintenance.



Electrical Troubleshooting

1. Turn all disconnect switches on the electrical enclosures to the Off position.
2. Lockout/tagout at the disconnect switches located on main electrical enclosure and the heater electrical enclosure.



	NOTICE
	<p>Never use compressed air inside an electrical enclosure. It may force contaminants into electrical connections.</p> <p>Use a vacuum to remove dust from electrical enclosures. Canned air is acceptable after vacuuming.</p>

3. Open the electrical enclosures.
4. Vacuum and dust the electrical enclosures.
5. Close the electrical enclosures.
6. Remove the lockout/tagout equipment and attempt to run the machine again. If that did not solve the problem, proceed with the next step.
7. Adhere to all regulations and guidelines given in NFPA 70e and in your company's energy control program. Some important safety tips are addressed on page 60.

	 WARNING
	<p>ELECTRICUTION HAZARD.</p> <p>All electrical work must be performed by a licensed electrician.</p> <p>If it is absolutely necessary to troubleshoot an energized machine, follow appropriate guidelines.</p>

8. Determine where the electrical problem begins. To do this, you need a multimeter.
 - Determine if you are working with AC (alternating current) or DC (direct current) before checking voltage.
 - Measure incoming and outgoing voltage to and from components. Proceed in a logical order determined by your machine's specific problem, and write down the order that you check each component and the amount of voltage that the multimeter registers.



Should you lockout/tagout to perform this action safely?

Identifying Problems and Solutions

Problem	Possible Cause	Possible Solution	Page
System does not operate	No power.	Check power supply and fuses.	
Power On indicator light on pushbutton enclosure does not stay illuminated.	E-stop activated.	Check E-stop status by selecting Alarm Control Menu > E-Stop Power and Diagnostic from the touch screen main menu.	74
	Selector switch on main electrical enclosure turned to Radio, but radio controller is turned off.	Turn radio controller on, or turn selector switch on main electrical enclosure to PB.	
	Selector switch on main electrical enclosure turned to Radio, but radio controller battery is dead.	Turn selector switch on main electrical enclosure to PB. Move a transporter using the manual controls on the pushbutton enclosure. If transporter moves, may need to replace battery in radio controller.	23
	Failure of master control relay in main electrical enclosure.	Check voltage in and out of the master control relay. If no voltage is present, may need to replace master control relay.	
Power On indicator light on pushbutton enclosure is illuminated but pumps do not run after a stacking area is selected.	Tripped overload in motor enclosure.	Check overload status by selecting Alarm Control Menu > Breaker & Overload from the touch screen main menu. If an overload tripped, reset it manually by pressing the red button on its front.	76
	Blown 3-phase fuse in motor enclosure.	Replace fuse.	
Pumps are running, but transporter does not raise truss	Truss weight or length exceeds capacity.	Reduce truss size.	



Should you lockout/tagout to perform this action safely?

Problem	Possible Cause	Possible Solution	Page
Pumps are running, but transporter does not raise or lower itself	Failure of solenoid on valve.	Use manual override to shift valve. If valve shifts, may need to replace solenoid.	
	Contaminated hydraulic fluid preventing valve from shifting.	Use manual override to shift valve. If valve does not shift, may need to replace fluid.	
	Dirty valve preventing spool from shifting.	Use manual override to shift valve. If valve does not shift, may need to replace valve.	
	Damaged cylinder.	Inspect cylinder. Replace if leaking or otherwise damaged.	
Transporter does not extend boom.	Transporter not hitting the raised limit switch.	Raise transporter to maximum height before extending.	23
	Tripped motor starter overload.	Check overload status by selecting Alarm Control Menu > Breaker & Overload from the touch screen main menu. If an overload tripped, reset it manually by pressing the red button on its front. If overload trips again, the overload, motor, or gearbox may be bad.	76
	Broken chain or sprocket.	Inspect chain and sprockets and replace if necessary.	
	Failure of motor or gearbox.	Inspect motor and gearbox and replace if necessary.	
Pumps are running, but transporter does not lower when extended.	Extended proximity switch adjusted incorrectly.	Adjust proximity switch.	59
	Failure of extended proximity switch.	May need to replace proximity switch.	
Transporter is down, but boom does not retract.	Stack height proximity switch needs adjustment.	Adjust proximity switch.	59
	Failure of stack height proximity switch.	May need to replace proximity switch.	
Excessively noisy drive chains on transporter when extending or retracting.	Too much slack in drive chains.	Tension chains properly.	47 48
	Sprockets misaligned.	Align sprockets.	



Should you lockout/tagout to perform this action safely?

Problem	Possible Cause	Possible Solution	Page
Excessively noisy pump.	Not enough hydraulic fluid in tank.	Make sure tank is filled to within 2" of the top.	51
	Fluid temperature too low.	Check disconnect on heater enclosure to make sure heaters are on. If disconnect is turned on, check heater fuses.	
	Dirty or clogged filter.	May need to replace filter.	52
	Pump not primed.	May need to verify priming.	55
	Failure of pump.	May need to replace pump.	
Radio controller is not working	Radio controller turned off.	Turn radio controller on.	
	Selector switch on main electrical enclosure turned to PB.	Turn selector switch to Radio.	
	Radio controller battery dead.	Turn selector switch on main electrical enclosure to PB. Move a transporter using the manual controls on the pushbutton enclosure. If transporter moves, may need to replace battery in radio controller.	23
	Failure of RD0 relay.* * The two RD0 relays are located in the radio controller enclosure.	Press and hold safety bar on radio controller. Verify that both RD0 relay indicator lights illuminate. If they do not, may need to replace relays.	30

Diagnostic Information for Troubleshooting

The touch screen shows the status of the following electronic components on the Horizontal Stacker:

- E-stops
- limit switches
- solenoids
- PLC
- motor starters
- motor overloads
- proximity switches

Access diagnostic menus from the main menu of the touch screen. Menus displaying diagnostic information are outlined in blue in Figure A-1. Explanations of the information displayed on these menus start on page 68.

Figure A-1: Diagnostic Menus

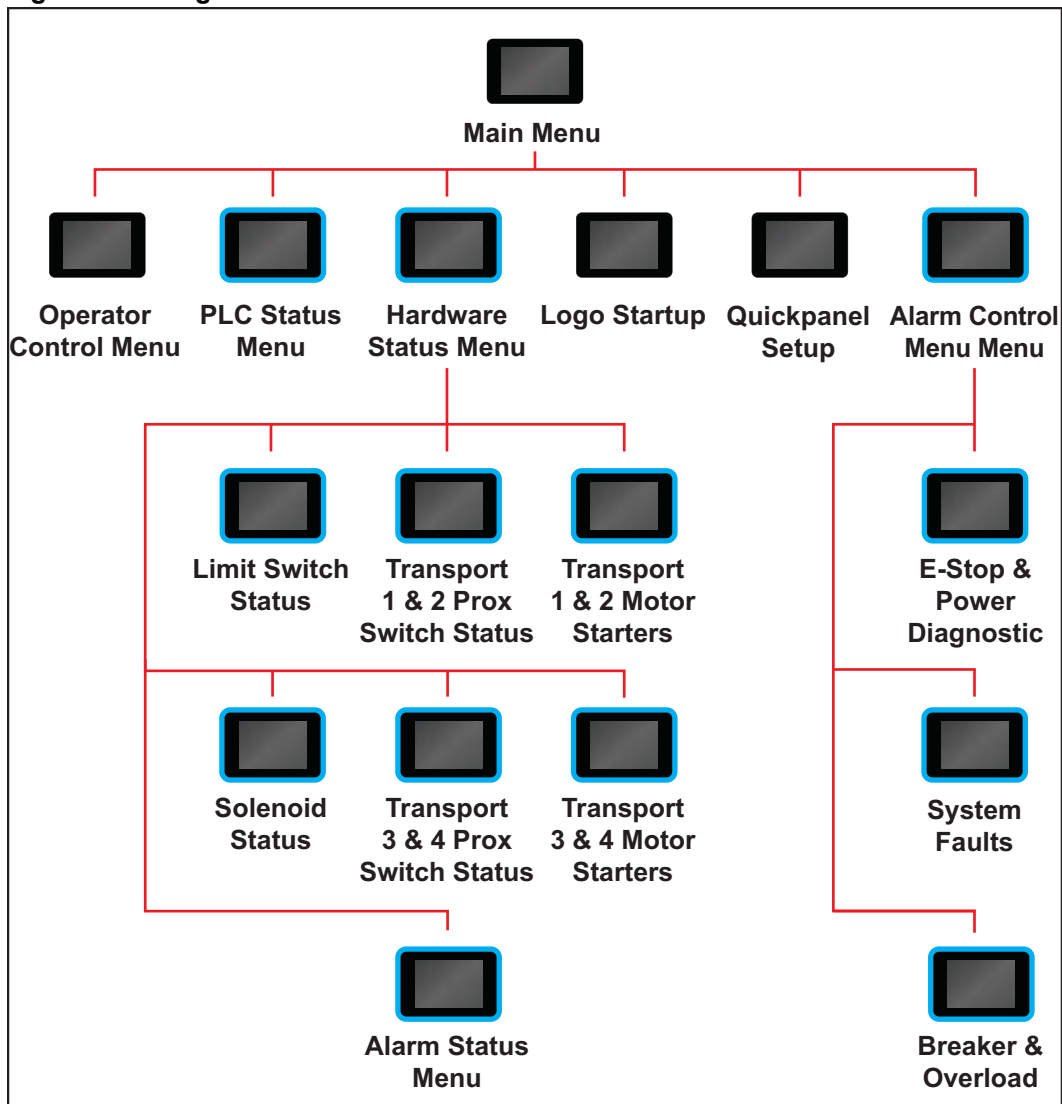

PLC Status Menu

Access the PLC status menu from the main menu. The PLC status menu displays information about the PLC and the touch screen.

Figure A-2: Sample PLC Status Menu

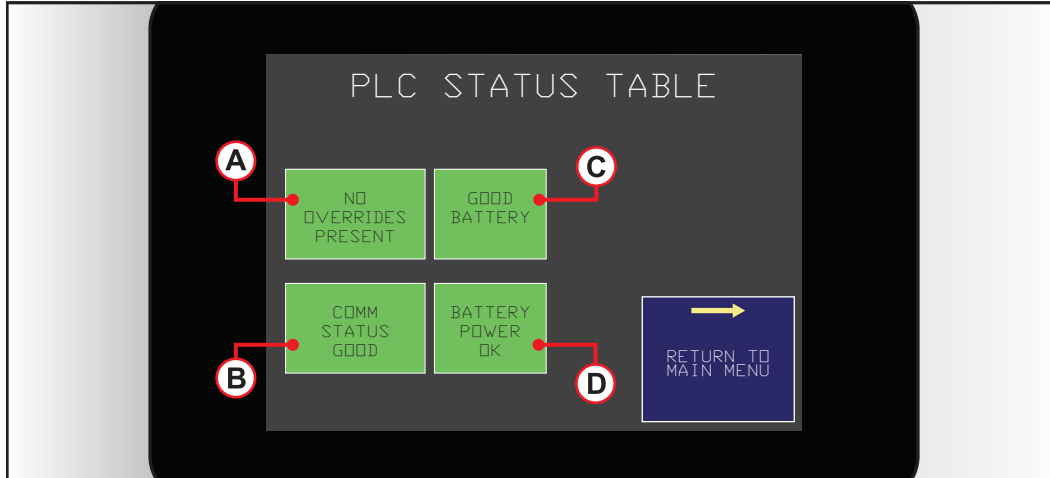

Table A-1: PLC Status Menu Details

Indicator	Detail
A	Verifies that PLC settings match the default factory settings
B	Verifies that PLC is communicating with touch screen via ethernet cable
C	Verifies that internal PLC battery inside CPU is functional
D	Verifies that external PLC power pack is functional

Hardware Status Menu

Access the hardware status menu from the main menu. Menu underneath this one provide information about limit switches, proximity switches, E-stop statuses, alarm statuses, and solenoid statuses.

Figure A-3: Hardware Status Menu

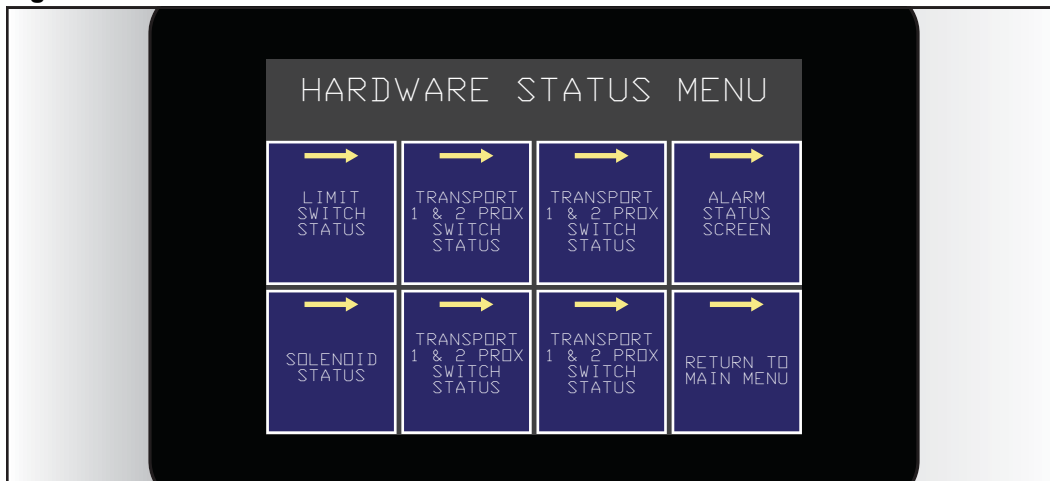

Limit Switch Conditions Menu

Limit switches on the transporters monitor whether the transporters are fully up or fully down.

- If the transporter is fully up, the UP indicator for that transporter displays ON.
- If the transporter is fully down, the DN indicator for that transporter displays ON.
- If the transporter is not fully up or fully down, the indicator displays OFF.

Figure A-4: Sample Limit Switch Conditions Menu

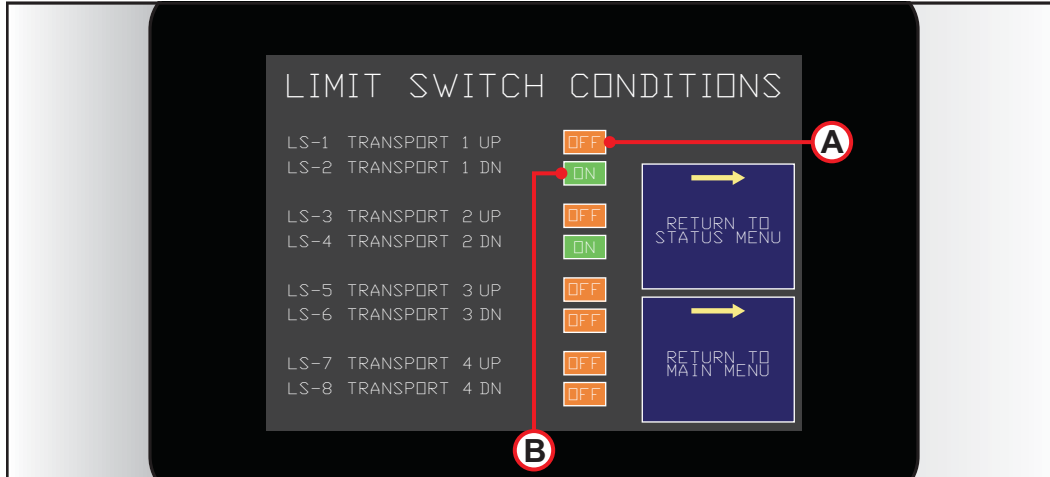

The graphic above shows a four-area system. In the graphic, transporters 1 and 2 are resting in the fully down position. Transporters 3 and 4 are neither fully up or fully down.

Figure A-5: Limit Switch Conditions Menu Details

Indicator	Detail
A	Shows that limit switch LS-1 is not in the fully up position
A	Turns to ON when limit switch LS-1 is in the fully up position
B	Shows that limit switch LS-2 is in the fully down position
B	Turns to OFF when limit switch LS-2 is not in the fully down position

Proximity Switch Conditions Menu

Proximity switches on the transporters monitor two types of conditions. First, proximity switches monitor whether a boom is extended or retracted. Second, other proximity switches monitor whether a boom is lowered onto a stack of trusses.

Figure A-6: Proximity Switch Conditions Menu

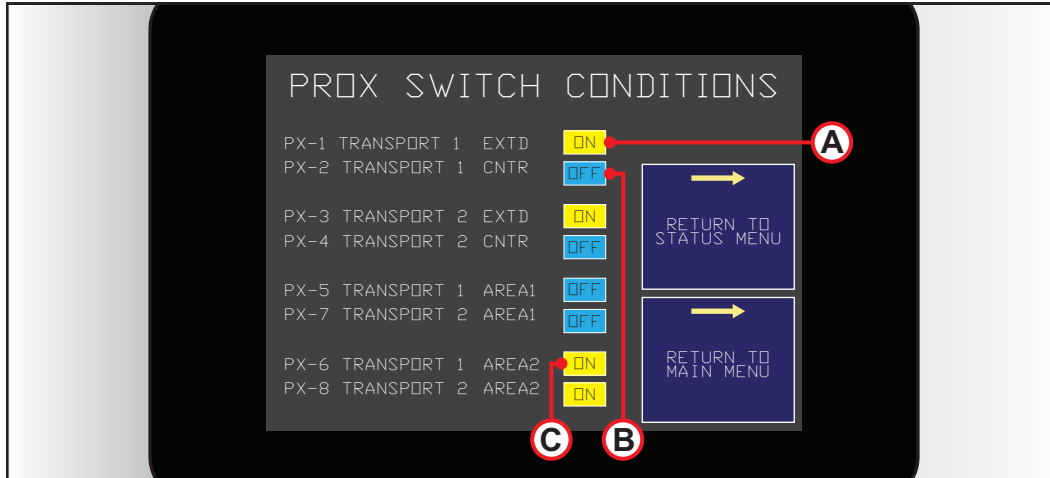

The graphic above shows a two-area system. In the graphic, both transporters in the system have their booms extended and resting on top of a stack in area 2.

Table A-2: Proximity Switch Conditions Menu Details

Indicator	Detail
A	Shows that proximity switch PX-1 is detecting a fully extended boom
A	Turns to OFF when proximity switch is not detecting a fully extended boom
B	Shows that proximity switch PX-2 is not detecting a centered boom
B	Turns to ON when proximity switch is detecting a centered boom
C	Shows that proximity switch PX-6 is detecting an extended, fully lowered boom
C	Turns to OFF when proximity switch does not detect an extended, fully lowered boom

Motor Starters Menu

Motor starters are used with both the hydraulic motor that raise and lower the transporters and the electric motor that drives the chains to extend and retract the boom. During normal operation, the motor starters and their auxiliary contacts turn on at the same time.

Figure A-7: Motor Starter Menu

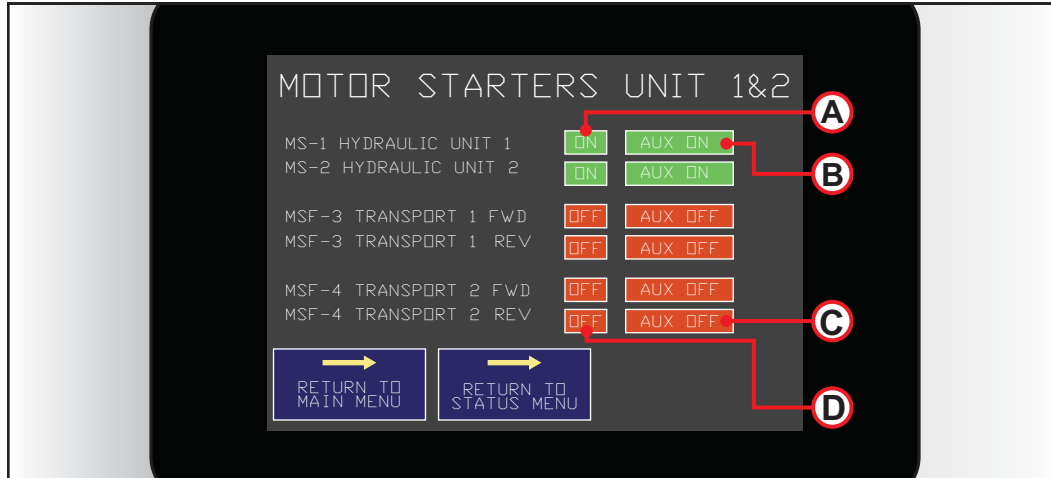

The graphic above shows a two-area system. In the graphic, the hydraulic motors are running for both transporters. The booms on both transporters are not moving.

Table A-3: Motor Starters Menu Details

Indicator	Detail
A	Shows that the motor starter MS-1 is running
A	Turns OFF when hydraulic motor 1 is not receiving power
B	Shows that the auxiliary contact for motor starter MS-1 is closed
B	Turns OFF when the auxiliary contact for motor starter MS-1 is open
C	Shows that the auxiliary contact for motor starter MSF-4 is open
C	Turns ON when the auxiliary contact for motor starter MSF-4 is closed
D	Shows that the motor starter MSF-4 is not receiving power
D	Turns ON when the electric motor on transporter 2 is running

Solenoid Conditions Menu

Solenoids are used to shift the hydraulic valve that opens when the transporters are moving up or down. The solenoid conditions menu displays information about solenoid outputs.

Figure A-8: Solenoid Conditions Menu

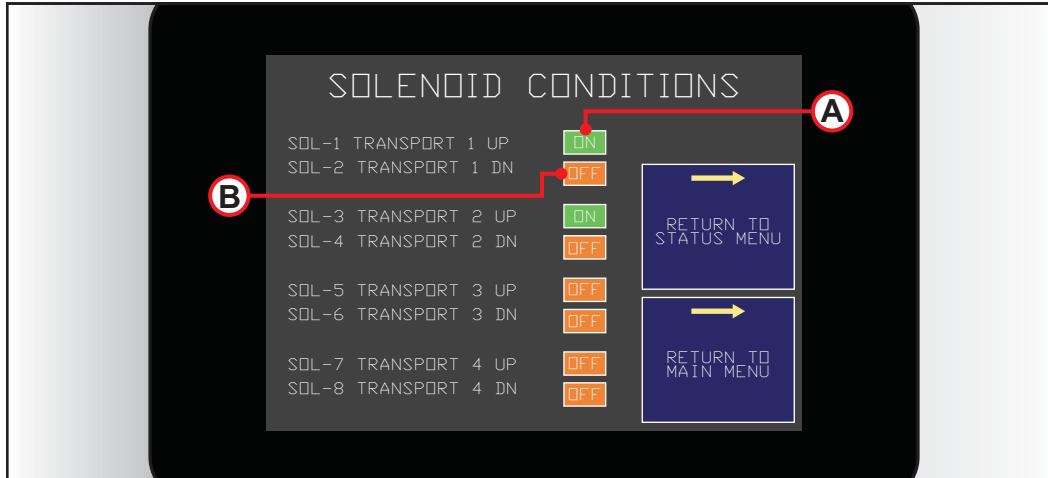

The graphic above shows a four-area system. In the graphic, transporters 1 and 2 are moving up.

Table A-4: Solenoid Conditions Menu Details

Indicator	Detail
A	Shows that the valve for transporter 1 is shifted to move the transporter up
A	Turns OFF when the valve for transporter 1 is not shifted to move the transporter up
B	Shows that the valve for transporter 1 is not shifted
B	Turns ON when the valve for transporter 1 is shifted to move the transporter down

Alarm Status Menu

The alarm status menu is located under the hardware status menu. It is identical to the alarm menu.

Alarm Menu

The alarm menu provides buttons to navigate to detailed diagnostic menus, including breakers and overloads, E-stop and power diagnostics, and system faults.

Figure A-9: Alarm Menu

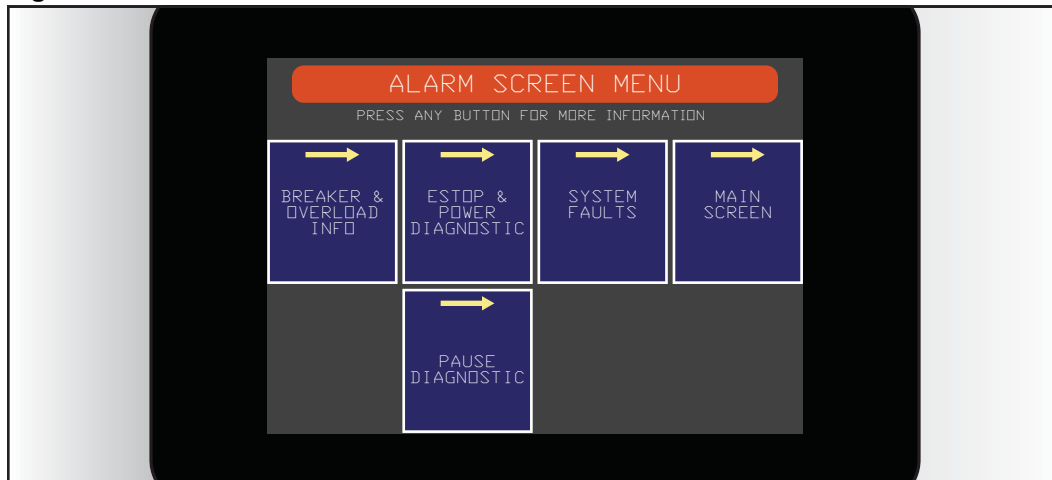

E-Stop and Power Diagnostic

E-stops are used to stop the system immediately in case of an emergency. Tilt switches are used to stop the system immediately in case a transporter or transporters starts to tilt from too heavy of a load. The alarm status menu displays information about tripped E-stops and tilt switches.

Figure A-10: Alarm Status Menu

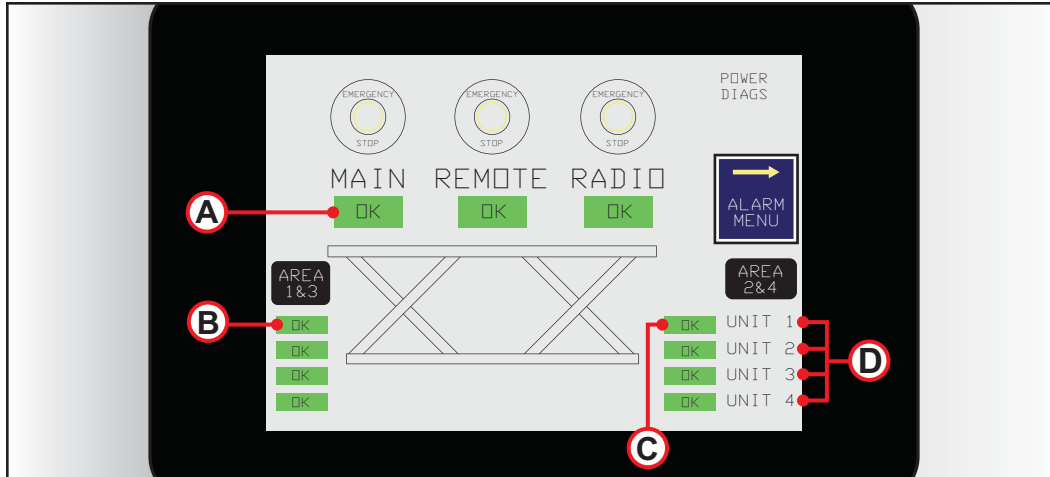

The graphic above shows a four-area system. In the graphic, no E-stops are activated, and no transporters are tipping.

Table A-5: Alarm Status Menu Details

Indicator	Detail
A	Shows that the E-stop has not been actuated
A	Turns to ERROR when E-stop is actuated
B	Shows that the tip switch on the area 1 and 3 side of transporter 1 is not registering a tipped transporter
B	Turns to ERR when the tip switch registers a tipped transporter
C	Shows that the tip switch on the area 2 and 4 side of transporter 1 is not registering a tipped transporter
C	Turns to ERR when the tip switch registers a tipped transporter
D	Identify which unit is having a problem with a tip switch

System Faults Menu

The PLC monitors overloads, circuit breakers, and motor starter inputs. If a component fails to start, the PLC registers a fault. The system faults menu displays information to locate an overload, breaker, or starter that experiences a fault.

Figure A-11: System Faults Menu

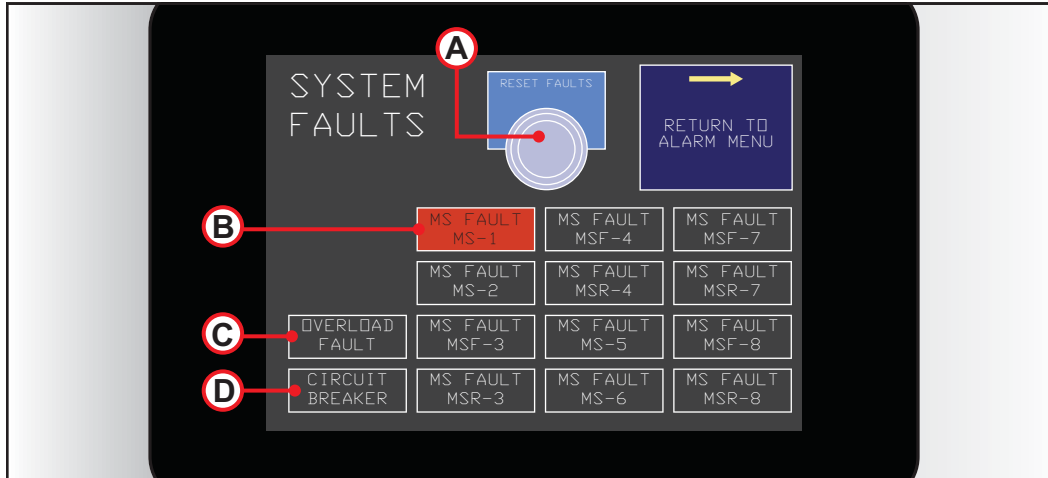

The graphic above shows a four-area system. In the graphic, the motor starter MS-1 is experiencing a fault.

Table A-6: System Faults Menu Detail

Indicator	Detail
A	Resets the system after it experiences a fault
B	Shows that motor starter MS-1 is experiencing a fault
B	Turns black when motor starter is not experiencing a fault
C	Shows that overloads are not experiencing a fault
C	Turns red when an overload experiences a fault (requires manual reset)
D	Shows that circuit breakers are not experiencing a fault
D	Turns red when a circuit breaker experiences a fault (requires manual reset)

Breaker and Motor Starter Overloads Menu

The PLC monitors breakers and overloads. The breaker and motor starter overloads menu displays information to locate a tripped breaker or overload.

Figure A-12: Breaker and Motor Starter Overloads Menu



The above graphic shows a tripped motor starter overload.

Table A-7: Breaker and Motor Starter Overloads Menu Details

Indicator	Detail
A	Shows that overload MS-1 is not experiencing a fault
A	Turns red when overload trips (requires manual reset)
B	Shows that the breaker for the radio controller is not experiencing a fault
B	Turns red when breaker trips
C	Shows that the PLC has power
C	Turns red when the PLC breaker trips (requires manual reset)
D	Shows that the PLC has power
D	Turns red when the PLC breaker trips (requires manual reset)

Parts List

Purpose of Appendix

This appendix lists MiTek replacement part numbers for your machinename.

Using the Parts List Appendix



The parts list provided here shows spare parts that you may need to repair or maintain your machinename. Locate part numbers using the technical drawings that accompany this manual or the MiTek website (www.mitek-us.com). Use one of the methods below to order parts.



Table B-1: Ordering Parts with a Part Number

By E-Mail	By Phone
Send an e-mail to mitekparts@mii.com with all relevant information, including the part number.	Call 1-800-523-3380. Select "parts orders."

Safety Notes for Replacement Parts

	NOTICE
	<p>Use only parts purchased from MiTek to replace parts on your machinename.</p> <p>Parts from other sources may damage your machinename.</p>

	 WARNING
	<p>ELECTRICAL HAZARD.</p> <p>All electrical work must be performed by a licensed electrician.</p> <p>Follow approved lockout/tagout procedures (OSHA 29 CFR 1910.147)</p>

	 WARNING
	ELECTROCUTION AND HIGH PRESSURE HAZARDS.
	Always turn the power off by activating an E-stop when the machine is not operating.
	Always verify that all power to the machine is off and followed approved lockout/tagout procedures (OSHA 29 CFR 1910.147) before performing any maintenance.

Part Numbers

Mechanical Parts

Part Location	MiTek Part Number	Description	Drawing Number	Keep in Stock
Boom	474127	Electric motor for drive chains	70300	
Boom	490077	Gear reducer for electric motor	70300	
Boom	419706	Pillow block bearing	70305-501	
Boom	580250	Crown tread wheel	70305-501	
Scissor arms	580251	Outer scissor arm wheel	70465-501	
Scissor arms	580252	Inner scissor arm wheel	70445-501	
Scissor arms	416011	Scissor arm bearing	70465-501	
Boom	70321	Chain adjustment takeup threaded rod	70305-501	
Boom	554005	No. 40 chain (per foot)	70305-501	
Boom	554007	No. 60 chain (per foot)	70305-501	
HPU	471003	Electric motor for hydraulic pump	70442-501	
HPU	800003	Gear pump	70442-501	

Hydraulic Parts

Part Location	MiTek Part Number	Description	Drawing Number	Keep in Stock
HPU	426351	Directional control valve	70442-501	
HPU	802269	Relief valve	70442-501	
HPU	805005	Filter with head	70442-501	
HPU	805222	Filter (replacement element only)	70442-501	2
HPU	780233	Hose	70440-901	
Cylinder	70441-601	Hose and fitting kit	70441-901	
Cylinder	70443-501	Cylinder assembly	70441-901	
Cylinder	798321	Cylinder	70443-501	
Cylinder	799074	Rod eye	70443-501	
Cylinder	803977	Velocity fuse	70443-501	
Cylinder	803921	Flow control valve	70443-501	

Electrical Parts

Part Location	MiTek Part Number	Description	Drawing Number	Keep in Stock
HPU	477069	Hydraulic fluid heater	90288-501	
Transporter	515069	Limit switch (raise / lower and tip switches)	90288-501	1
Transporter	515063	Limit switch adjustable roller arm	90288-501	1
Transporter	515825	Proximity switch	90288-501	2
Main encl.	509108	Line conditioner	90436-501	
Main encl.	92281-505	PLC CPU (programmed)	90436-501	
Main encl.	519932	PLC rack	90436-501	
Main encl.	519916	PLC power supply	90436-501	
Main encl.	519910	PLC input card	90436-501	
Main encl.	519911	PLC output card	90436-501	
Main encl.	514071	Master control relay	90436-501	
Main encl.	514186	Control relay	90436-501	
Main encl.	504371	Ethernet switch	90436-501	
Main encl.	509149	24VDC power supply	90436-501	
Main encl.	513527	Lens for beacon (red)	90436-501	
Main encl.	513525	Lens for beacon (green)	90436-501	
Main encl.	513522	Lens for beacon (orange)	90436-501	
Main encl.	513526	Lens for beacon (blue)	90436-501	
Motor encl.	509211	10A non-reversing motor starter	90436-502	
Motor encl.	509217	48A non-reversing motor starter (460V)	90436-502	
Motor encl.	509223	22A non-reversing motor starter (208 / 230V)	90436-502	
Motor encl.	509226	Surge suppressor	90436-502	
Scanner	513521	Beacon base	70560	
Scanner	513527	Beacon lens (red)	70560	
Scanner	515780	Photoeye	70560	
Scanner	515781	Photoeye cover	70560	

Documentation Parts

Documentation	MiTek Part Number
Manual	001011MANUAL

Label Part

Number	Label
691407	

Maintenance Checklist

Purpose of Appendix



This appendix consists of checklists to plan and record preventative maintenance procedures.



Using the Maintenance Checklists

Copy these checklists and place the copies with the machinename. Leave the original checklists in this manual for future use.

Checklist	Page
Daily checklist	83
Weekly checklist	84
Monthly checklist	85

Safety Notes for the Maintenance Checklists



	 WARNING
	<p>CRUSH HAZARD.</p> <p>Perform the safety tests starting on page xiii before operating the machine after performing maintenance or repairs.</p>

	 WARNING
 	<p>ELECTROCUTION AND HIGH PRESSURE HAZARDS.</p> <p>Always turn the power off by activating an E-stop when the machine is not operating.</p> <p>Always verify that all power to the machine is off and followed approved lockout/tagout procedures (OSHA 29 CFR 1910.147) before performing any maintenance.</p>

Daily Checklist

Month and year _____

Week of _____



	 WARNING
	<p>Lockout/tagout before performing maintenance.</p> <p>If power is required, make sure all personnel are clear of the restricted zone.</p>

Action	Page	Shift	Initials / Date				
Perform safety test	xiii	1					
		2					
		3					
Check pressure gauge on hydraulic fluid filter	52	1					
		2					
		3					
Check hydraulic fluid sight gauge for fluid level and dirty fluid	51	1					
		2					
		3					

Date	Notes
_____	_____
_____	_____
_____	_____
_____	_____
_____	_____
_____	_____

Weekly Checklist

Year _____



	 WARNING
	<p>Lockout/tagout before performing maintenance.</p> <p>If power is required, make sure all personnel are clear of the restricted zone.</p>

Action	Page	Initials / Date					
Check chain tension	47, 48						
Lubricate chains	42						
Inspect gear reducer for signs of fluid leakage							
Vacuum any accumulation of dust or dirt from the electrical enclosures (do NOT use compressed air)							
Check wires in terminals to make sure they are tight							

Date	Notes
_____	_____
_____	_____
_____	_____
_____	_____
_____	_____
_____	_____

Monthly Checklist

Year _____

	 WARNING
	<p>Lockout/tagout before performing maintenance.</p> <p>If power is required, make sure all personnel are clear of the restricted zone.</p>

Action	Page	Months (one shift)	Months (two shifts)	Initials / Date			
Lubricate boom wheel bearings	43	3	1.5				
Lubricate scissor arm middle bearings	44	3	1.5				
Lubricate scissor arm wheel bearings	44	3	1.5				
Lubricate scissor arm end bearings	45	3	1.5				
Lubricate hydraulic cylinder pins	45	3	1.5				
Lubricate pillow block bearings	46	6	3				
Check air gap in electric motor brake	49	12	6				
Replace hydraulic fluid filter element*	52	12	6				
Test hydraulic fluid cleanliness level	52	12	6				
Replace hydraulic fluid	53	60	30				

* May need more frequent replacement. See page 52.

Date	Notes
_____	_____
_____	_____
_____	_____
_____	_____
_____	_____
_____	_____

Drawing Set

**Purpose
of Appendix**

This appendix consists of a list of schematics and other drawings to help you understand and troubleshoot your machine.

Drawings are inserted in the back of the manual or included in a separate binder, depending on the machine.

Table D-1: Drawing Set

Description	Drawing Number
Transporter assembly	70300
Transporter top / middle / bottom drives assembly	70305
Transporter scissor arms assembly	70435
Hydraulic pressure unit kit assembly	70440-901
Hydraulic pressure unit assembly	70442-501
Cylinder kit assembly	70441-901
Cylinder assembly	70443-501
Traffic cop assembly	70530
Scanner assembly	70560
Scanner assembly on rail	75740
Field wiring (two-area system)	90013
Field wiring (four-area system)	90014
Electrical assembly	90288
Electrical schematic	90436
Main electrical enclosure	90436-501
Motor electrical enclosure	90436-502
Heater electrical enclosure	90436-503
Pushbutton electrical enclosure	90436-504
Radio control electrical enclosure schematic	92275
Enclosure layout (two-area system)	90436-520
Enclosure layout (four-area system)	90436-540

Document Evaluation

**Purpose
of Appendix**

This appendix provides a form so that you may evaluate this manual.

MiTek Machinery Division makes a continuous effort to provide customers with helpful, accurate documentation.

Please complete this form to provide us with comments or suggestions that improve the quality of our documentation.

Document Evaluation Form

machinename	Operation and Maintenance Manual	001011MANUAL REV. E
-------------	----------------------------------	---------------------

General Evaluation

	Poor	fair	good	excellent
Content				
Organization				
Accuracy				
Clarity				
Completeness				
Illustrations				
Readability				

Specific Evaluation

Identify any inaccuracies in this manual. Please include page numbers.	
What are the best features of this manual?	
What are the worst features of this manual?	
Name:	Date:
Company:	Address:
Phone:	E-mail:
Return the form by mail: MiTek Machinery Division 301 Fountain Lakes Industrial Drive Saint Charles, MO 63301 Attn: Engineering Manager	Return this form by fax: 636-328-9218 Attn: Engineering Manager
If you do not receive a reply within 45 days, please call Machinery Division Customer Service and ask for the documentation specialist or engineering manager.	

Glossary

**Purpose
of Appendix**

This appendix provides definitions of terminology that apply to your machine.

actuate	to activate, put into action
affected employee	an employee whose job requires him or her to operate or use a machine or equipment on which servicing or maintenance is being performed under lockout or tagout, or whose job requires him or her to work in an area in which such servicing or maintenance is being performed
aisle pad	a type of jiggging used when a connector plate needs to be embedded where the table surface gives way to a walk-through aisle
amperage	the strength of an electric current, expressed in amperes
anchor plate	a steel plate that holds the tables in place; it is anchored to the concrete floor and the tables are welded to it
area	as used in this manual, an area refers to a place next to the transporters where the receiver stands are placed and the trusses are stacked
authorized employee	a person who locks out or tags out a machine or equipment in order to perform servicing or maintenance on that machine or equipment; an affected employee becomes an authorized employee when that employee's duties include performing servicing or maintenance covered under this section
beacon	a light that displays one of several colors to represent the state of the machine
boom	the parts of the transporter that extend and retract to place a truss into an area
connector plate	the nail-plate that is embedded into production material to hold it together
energized	connected to an energy source or containing residual or stored energy
energy isolating device	a mechanical device that physically prevents the transmission or release of energy, including but not limited to the following: manually operated electrical circuit breaker; a disconnect switch; a manually operated switch by which the conductors of a circuit can be disconnected from all ungrounded supply conductors, and in addition, no circuit can be operated independently; a line valve; a block; and any similar device used to block or isolate energy—push buttons, selector switches, and other control circuit type devices are not energy isolating devices

energy source	any source of electrical, mechanical, hydraulic, pneumatic, chemical, thermal, or other energy
jigging	any of several devices used to hold the truss in place on the tables
layout	a scaled diagram of the location of components and the space that they occupy
limit switch	an electro-mechanical device that consists of an actuator mechanically linked to a set of contacts; when an object comes into contact with the actuator, the device operates the contacts to make or break an electrical connection
lockout device	a device that utilizes a positive means such as a lock, either key or combination type, to hold an energy isolating device in the safe position and prevent the energizing of a machine or equipment, including blank flanges and bolted slip blinds; should be standardized within the facility in at least one of the following criteria: color; shape; or size; and additionally, in the case of tagout devices, print and format shall be standardized
lockout/tagout	a means of isolating a piece of equipment from its energy source so maintenance can safely occur; guidelines provided in OSHA 29 CFR 1910.147
operator control interface	the method in which the operator controls the machine; it may be a touch screen, a control panel, etc.
plate	see <i>connector plate</i>
PLC	(programmable logic controller) a solid-state control device that can be programmed to control process or machine operations. It consists of five basic components: processor, memory, input/output module, the power supply, and the programming device.
port	a connection point for a peripheral device
proximity switch	a switch that uses an electromagnetic field to detect when an object is near, there is no physical contact between the object and the switch; inductive proximity switches detect only metal objects, capacitive proximity switches can sense both metallic and non-metallic objects
qualified person	a person or persons who, by possession of a recognized degree or certificate of professional training, or who, by extensive knowledge, training, or experience, has successfully demonstrated the ability to solve problems relating to the subject matter and work—ANSI B30.2-1983; one who has skills and knowledge related to the construction and operation of the electrical equipment and installations and has received safety training on the hazards involved—NEC2002 Handbook

radio controller	A handheld device that operates the system in the same way as the pushbutton enclosure (includes radio controller, receiver, antenna, battery pack, etc.)
receiver stands	Stands consisting of horizontal rails that keep trusses elevated and vertical poles that keep them from shifting
scanner target	A device that detects the presence of a truss as it passes on the Stand-Alone Conveyors and signals the transporters to start moving
scissor arms	the arms that connect the base of the transporter to the boom to raise and lower it; these form an X when extended
solenoid	an assembly used as a switch consisting of a coil and a metal core free to slide along the coil axis under the influence of the magnetic field
stand-alone conveyor	the conveyor system that carries the truss from the tables to the Finish Roller and out to the stacker
stop	a type of jiggling that is long and straight
tagout device	a prominent warning device, such as a tag and a means of attachment, which can be securely fastened to an energy isolating device in accordance with an established procedure, to indicate that the energy isolating device and the equipment being controlled may not be operated until the tagout device is removed; should be standardized within the facility in at least one of the following criteria: color; shape; or size; and additionally, in the case of tagout devices, print and format shall be standardized
torque	a turning or twisting force
traffic cop	A device that prevents collisions between a truss and a transporter by pausing the Finish Roller, Stand-Alone Conveyors, or both when the transporter is moving
transfer roller	a motorized roller sitting perpendicular to the tables on an auto-eject system; it automatically transfers the truss from the Ejectors to the stand-alone conveyors
transporter	A lift equipped with hydraulic cylinders that lift a truss above the Stand-Alone Conveyors and with a boom that moves the truss over receiver stands
VFD	(variable frequency drive) controls the speed of a cycle
voltage	Equal to the difference of electric potential between two point on a conducting wire carrying a constant current of one ampere when the power between the points is one watt

Index

**Purpose
of Appendix**

This appendix consists of an index to assist in navigating the manual.

A

air gap *see* brake
Aire comprimido xxiv
aire en lata xxiv
area *see* stacking area
automatic mode *see* operation
avisos de seguridad *vea* los simbolos de seguridad

B

bloqueo/etiquetado
definición xxvi
brake 49

C

canned air vii, 35
capacity of hydraulic fluid *see* hydraulic fluid
chains
lubrication 42
checklists
daily checklist 83
maintenance 82
monthly checklist 85
weekly checklist 84
component overviews 7, 38
compressed air vii, 35
conformidad
de seguridad xxxviii
contact information 3
controls *see* operator controls
corrections ii
customer service 3

D

daily checklist 83
disconnect switch
switch 16
document evaluation 88

E

electrical enclosures 38
e-mail support *see* customer service
emergency stop *see* E-stop
equipment weight *see* weight

errors ii
E-stop 14
checking function xiv
disconnect switch 16
pushbutton 15
evaluation of document 88
extreme temperature *see* temperature

F

flow control valves 56
Función de verificar
el Paro de emergencia xxxi

G

gearbox
lubrication 51
garmotor
changing direction 59

H

hydraulic fluid
adding 51, 52
capacity 10
checking 51
priming pump 55
replacing 53
replacing filter element 52
specifications 50
hydraulic pressure unit
overview 39
hydraulic system troubleshooting 64, 65, 66
hydraulic unit *see* hydraulic pressure unit

I

important parts *see* component overviews
indicadores
de seguridad xxii
indicators on machine 17, 18

L

light stack 17
lights *see* indicators on machine
lockout/tagout
definition ix

electrical procedure x, xi
 hydraulic 40
 hydraulic procedure xii
 symbol ix, 2, 31, 34
 lubrication
 bearings and pins 43
 chains 42
 gearbox 51

M

machine weight *see* weight
 Machinery Division Customer Service 3
 maintenance
 checklists 82
 safety 33
 manual
 formatting cues 2
 introduction 1
 navigation 2
 purpose 1
 manual evaluation *see* document evaluation
 manual mode *see* operation
 monthly checklist 85
 motor *see* gearmotor

O

oil for gearbox *see* lubrication
 operating temperature *see* temperature
 operation
 automatic mode 26
 manual mode 23
 radio controller 30
 resetting 28
 starting 22
 stopping 14
 temperature 9
 touch screen 29
 operator controls 19

P

palabras
 de aviso de seguridad xxii
 part overviews *see* component overviews
 parts list 77
 electrical 80
 hydraulic 79
 labels 81
 mechanical 79
 patents ii
 phone support *see* customer service
 PLC
 overview 39

Procedimientos de
 bloqueo/etiquetado eléctricos xxvii,
 xxviii
 programmable logic controller *see* PLC
 proximity switch
 setting 59
 troubleshooting 65
 pruebas
 de seguridad xxx
 purpose of manual 1

R

radio controller
 E-stop 15
 troubleshooting 64, 66
 radio controller *see* operation
 reglas
 generales de seguridad xxiii
 replacement parts *see* parts list
 resetting *see* operation
 restricted zone xv
 return goods ii
 reversing direction of motor 59

S

safety
 conformity xxi, 4
 during troubleshooting 60
 general rules vi
 indicators v
 lockout/tagout ix
 restricted zone xv
 signal words v
 symbols xvi
 tests xiii
 troubleshooting with energy xii
 safety ratings *see* safety conformity
 safety signs *see* safety symbols
 scanner lights *see* indicators on machine
 seguridad
 bloqueo/etiquetado xxvi
 zona restringida xxxii
 simbolos
 de seguridad xxxiii
 spare parts *see* parts list
 specifications
 hydraulic fluid capacity 10
 hydraulic fluid type 50
 stacking area 5, 6
 stickers *see* parts list
 stop motion *see* E-stop
 support *see* customer service
 switches

disconnect 16

T

temperature 9

tensioning

chains 47

tip switch 57

touch screen see operation

transporter weight see weight

W

weekly checklist 84

weight 8

Z

Zona restringida xxxii

zone see stacking area

1" binder

1/2" binder

2" binder

Horizontal Stacker™

®

®

Component Cutting Saw
Installation Manual

001011